	Reference D1270292	Release 1.01p <small>(Printed copy not controlled: verify the version before using)</small>
	Classification level Public	Pages 133

Security Target

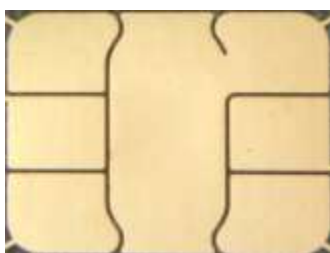

Mobile PayPass 1.0 on UpTeq NFC2.0.4_OFM (Module Offer)





	Reference	D1270292	Release	1.01p <small>(Printed copy not controlled: verify the version before using)</small>
	Classification level	Public	Pages	133

Table of Contents

1	INTRODUCTION.....	7
1.1	ST REFERENCE.....	7
1.2	TOE REFERENCE	7
1.3	REFERENCE MATERIALS.....	8
1.4	DEFINITIONS.....	10
1.5	ACRONYMS AND ABBREVIATIONS	11
1.6	TOE OVERVIEW	13
1.6.1	<i>TOE type</i>	<i>13</i>
1.6.2	<i>Usage and major security features of the TOE</i>	<i>14</i>
1.6.2.1	Mode 1: PIN – TAP.....	16
1.6.2.2	Mode 2: TAP – PIN – TAP:	16
1.6.2.3	Security features	17
1.6.3	<i>Required non-TOE hardware/software/firmware</i>	<i>17</i>
1.6.3.1	Payez Mobile Application (AEPM CREL Application)	18
1.6.3.2	Proximity Payment System Environment (PPSE) application (EMVCo CREL Application).....	18
1.6.3.3	Payment Bridge application.....	18
1.6.3.4	Bank TSM.....	19
1.6.3.5	UICC Management Platform	19
1.6.3.6	Bank GUI Management Platform	19
1.6.3.7	POS terminal	19
1.6.3.8	POS Application	19
1.6.3.9	Mobile Handset	19
1.6.3.10	Bank GUI.....	19
1.6.3.11	MNO GUI.....	20
1.6.3.12	OTA Platform	20
1.7	TOE DESCRIPTION	20
1.7.1	<i>Physical scope of the TOE: all hardware, firmware, software and guidance.....</i>	<i>20</i>
1.7.1.1	Payment Application Package (PAP)	23
1.7.2	<i>Logical scope of the TOE: the logical security features offered by the TOE</i>	<i>24</i>
1.7.2.1	Contactless Availability	24
1.7.2.2	Script Processing Module	24
1.7.2.3	Counters Management	25
1.7.2.4	Counter Reset Processing Module	25
1.7.2.5	Transaction Log Module	25
1.7.2.6	Detect GUI Presence Module	25
1.7.2.7	HCI Events Manager Module	25
1.7.2.8	Over-The-Air (OTA) Capabilities.....	25
1.7.3	<i>Overview of the TOE Life Cycle</i>	<i>26</i>
1.7.3.1	TOE role and environment	28
1.7.4	<i>PAP on-card life cycle.....</i>	<i>29</i>
1.7.4.1	Contactless life cycle	29
1.7.4.2	GP standard life cycle.....	30
1.7.5	<i>Configurations</i>	<i>31</i>
2	CONFORMANCE CLAIM	32
2.1	CC CONFORMANCE CLAIM	32
2.2	PP AND PACKAGE CLAIM.....	32
3	STATEMENT OF COMPATIBILITY.....	33
3.1	COMPATIBILITY OF THREATS.....	34

	Reference	D1270292	Release	1.01p <small>(Printed copy not controlled: verify the version before using)</small>
	Classification level	Public	Pages	133

3.2	COMPATIBILITY OF OSP.....	36
3.3	COMPATIBILITY OF ASSUMPTIONS	40
3.4	COMPATIBILITY OF TOE SECURITY OBJECTIVES	41
3.5	COMPATIBILITY OF SECURITY OBJECTIVES FOR THE ENVIRONMENT	45
3.6	COMPATIBILITY OF SECURITY FUNCTIONAL REQUIREMENTS	48
3.7	COMPATIBILITY OF SECURITY FUNCTIONAL REQUIREMENTS FOR THE ENVIRONMENT.....	51
3.8	COMPATIBILITY OF ASSURANCE REQUIREMENTS	51
4	SECURITY PROBLEM DEFINITION	52
4.1	ASSETS.....	52
4.1.1	<i>User data</i>	52
4.1.2	<i>TSF data</i>	53
4.1.2.1	TRANSACTION MANAGEMENT DATA.....	53
4.1.2.2	TEMPORARY TRANSACTION DATA	53
4.2	USERS / SUBJECTS.....	54
4.2.1	<i>USERS</i>	54
4.2.2	<i>SUBJECTS</i>	54
4.3	THREATS.....	55
4.3.1	<i>DISCLOSURE</i>	55
4.3.2	<i>INTEGRITY</i>	55
4.3.3	<i>FRAUDULENT PAYMENT</i>	56
4.3.4	<i>DENIAL-OF-SERVICE</i>	57
4.3.5	<i>IDENTITY_USURPATION</i>	57
4.4	ORGANISATIONAL SECURITY POLICIES	58
4.4.1	<i>HANDSET</i>	58
4.4.2	<i>MANAGEMENT</i>	58
4.4.3	<i>MERCHANT</i>	59
4.4.4	<i>BANK</i>	59
4.5	ASSUMPTIONS	59
5	SECURITY OBJECTIVES	60
5.1	SECURITY OBJECTIVES FOR THE TOE	60
5.1.1	<i>TRANSACTION PROTECTION</i>	60
5.1.2	<i>AUTHENTICATION</i>	60
5.1.3	<i>EXECUTION PROTECTION</i>	60
5.1.4	<i>DATA PROTECTION</i>	61
5.1.5	<i>RISK MANAGEMENT</i>	61
5.1.6	<i>GUI</i>	62
5.2	SECURITY OBJECTIVES FOR THE OPERATIONAL ENVIRONMENT	62
5.2.1	<i>HANDSET</i>	62
5.2.2	<i>MERCHANT</i>	63
5.2.3	<i>MANAGEMENT</i>	63
5.2.4	<i>BANK</i>	64
5.3	SECURITY OBJECTIVES RATIONALE.....	64
5.3.1	<i>Threats</i>	64
5.3.1.1	DISCLOSURE	64
5.3.1.2	INTEGRITY.....	64
5.3.1.3	FRAUDULENT PAYMENT	66
5.3.1.4	DENIAL-OF-SERVICE.....	68
5.3.1.5	IDENTITY_USURPATION	69
5.3.2	<i>Organisational Security Policies</i>	69
5.3.2.1	HANDSET	69
5.3.2.2	MANAGEMENT	69
5.3.2.3	MERCHANT	70

	Reference	D1270292	Release	1.01p <small>(Printed copy not controlled: verify the version before using)</small>
	Classification level	Public	Pages	133

5.3.2.4	BANK	70
5.3.3	<i>Assumptions</i>	71
5.3.4	<i>SPD and Security Objectives</i>	71
6	SECURITY REQUIREMENTS	78
6.1	SECURITY FUNCTIONAL REQUIREMENTS	78
6.1.1	<i>ACCESS CONTROL POLICY</i>	80
6.1.2	<i>ACCESS CONTROL FUNCTIONS</i>	83
6.1.3	<i>INFORMATION FLOW CONTROL POLICY</i>	89
6.1.4	<i>SECURITY AUDIT</i>	94
6.1.5	<i>CRYPTOGRAPHIC SUPPORT</i>	95
6.1.6	<i>PROTECTION</i>	97
6.1.7	<i>MANAGEMENT</i>	98
6.1.8	<i>IDENTIFICATION / AUTHENTICATION</i>	100
6.1.9	<i>ACCESS and INFORMATION FLOW CONTROL SFP</i>	104
6.1.10	<i>SECURE CHANNEL</i>	105
6.1.11	<i>UNOBSERVABILITY</i>	106
6.2	SECURITY ASSURANCE REQUIREMENTS.....	106
6.3	SECURITY REQUIREMENTS RATIONALE	107
6.3.1	<i>Objectives</i>	107
6.3.1.1	Security Objectives for the TOE	107
6.3.2	<i>Rationale tables of Security Objectives and SFRs</i>	113
6.3.3	<i>Dependencies</i>	126
6.3.3.1	SFRs Dependencies.....	126
6.3.3.2	SARs Dependencies	130
6.3.4	<i>Rationale for the Security Assurance Requirements</i>	131
6.3.5	<i>ALC_DVS.2 Sufficiency of security measures</i>	131
6.3.6	<i>AVA_VAN.5 Advanced methodical vulnerability analysis</i>	131
7	TOE SUMMARY SPECIFICATION.....	132
7.1	SECURITY FUNCTIONS.....	132
7.2	ASSURANCE MEASURES.....	133

	Reference D1270292	Release 1.01p <small>(Printed copy not controlled: verify the version before using)</small>
	Classification level Public	Pages 133

Table of Figures

Figure 1: TOE type.....	14
Figure 2: Mode 1: PIN - TAP	16
Figure 3: Mode 2 - TAP - PIN – TAP.....	17
Figure 4: TOE physical scope like in [PAP]	20
Figure 5: TOE logical boundaries	21
Figure 6: Major TOE items and scope.....	22
Figure 7: PAP Module	24
Figure 8: TOE life cycle overview	26
Figure 9: TOE life cycle	27
Figure 10: Contactless life cycle states	30
Figure 11: GP standard life cycle states.....	31
Figure 12: Conformance and Composition	33



	Reference D1270292	Release 1.01p <small>(Printed copy not controlled: verify the version before using)</small>
	Classification level Public	Pages 133

Table of Tables

Table 1: Compatibility of threats.....	35
Table 2: Compatibility of OSP.....	39
Table 3: Compatibility of assumptions.....	40
Table 4: Compatibility of TOE security objectives.....	44
Table 5: Compatibility of security objectives for the environment	47
Table 6: Compatibility of security functional requirements.....	51
Table 7: Threats and Security Objectives - Coverage	72
Table 8: Security Objectives and Threats - Coverage	74
Table 9: OSPs and Security Objectives - Coverage.....	75
Table 10: Security Objectives and OSPs - Coverage.....	76
Table 11: Assumptions and Security Objectives for the Operational Environment - Coverage	77
Table 12: Security Objectives for the Operational Environment and Assumptions - Coverage	77
Table 13: Security Objectives and SFRs - Coverage	118
Table 14: SFRs and Security Objectives	125
Table 15: SFRs Dependencies	129
Table 16: SARs Dependencies	131

	Reference D1270292	Release 1.01p <small>(Printed copy not controlled: verify the version before using)</small>
	Classification level Public	Pages 133

1 Introduction

This document written from the AEPM's Guidance for Payment Application Package Security Target [PAP], provides a list of security requirements for a Payment Application Package (PAP) embedded in a (U)SIM module as specified in [PM] specifications.

This document is the Security Target for the **Mobile PayPass 1.0 on UpTeq NFC2.0.4_OFM**, a Gemalto specific implementation of a TOE. This Product-specific fulfills the generic security requirements given in this security target in order to ensure End users, Orange Mobile Network Operator (MNO) and Issuing Banks trust.

1.1 ST reference

Title:	Mobile PayPass 1.0 on UpTeq NFC2.0.4_OFM - Security Target
Reference:	D1270292
Version:	1.01p
Date of Issue:	November 30 th , 2012
Author:	Gemalto
ITSEF:	THALES CEACI
Certification Body:	ANSSI
CC Version:	CC 3.1 revision 3
Status:	Release

This Security Target describes:

- The Target of Evaluation (TOE)
- The assets to be protected, the threats to be countered by the TOE itself during the usage of the TOE,
- The organizational security policies, and the assumptions,
- The security objectives for the TOE and its environment,
- The security functional requirements for the TOE and its IT environment,
- The TOE security assurance requirements,
- The security functions and associated rationales.

1.2 TOE reference

TOE is the composition of applet on (U)SIM platform.

Developer's name:	Gemalto
Product name:	Mobile PayPass 1.0 on UpTeq NFC2.0.4_OFM
Product version:	Release B
Name of applet:	Mobile PayPass v1.0
Reference of applet:	S1109398
Version of applet:	Release A
Name of (U)SIM platform:	UpTeq NFC2.0.4_OFM platform using ST33F1M
Reference of (U)SIM platform:	S1121881
Version of (U)SIM platform:	Release B

And its guidances

Guidance of applet:	[GUIDE]
Guidance of (U)SIM platform:	[NFC-GUIDE]

	Reference D1270292	Release 1.01p <small>(Printed copy not controlled: verify the version before using)</small>
	Classification level Public	Pages 133

1.3 Reference Materials

Please refer to Part I: "Product Definition" [PM-1] – Section 2.4.

	Reference D1270292	Release 1.01p <small>(Printed copy not controlled: verify the version before using)</small>
	Classification level Public	Pages 133

References	Description
[PM-1]	Part I: Product Definition v1.0 – April 2011
[PM-2]	Part II: Technical Specification v1.0 – April 2011
[PM-3]	Security Guidelines for Standard Operational Environment v1.0 – June 2009
[PM-6]	<i>Payez Mobile</i> MasterCard Implementation Guide – April 2011
[PP USIM]	(U)SIM Java Card Platform Protection Profile Basic Configuration V2.0.2, June 2010
[PP JCS]	Java Card™ System Protection Profile “Open Configuration” Version 2.6
[GP]	Global Platform 2.2, Specification GP
[GP-CCCM]	GlobalPlatform Card - Confidential Card Content Management, Card specification v2.2 – Amendment A. Version 1.0.1. October2007
[GP-4]	GlobalPlatform Card Specification 2.2 - UICC Configuration v1.0
[GP-5]	GlobalPlatform Card – Amendment C v1.0.
[PAP]	Guidance for Payment Application Package to write Security Target AEPM, ref: CP-2011-RT-407 / Version 1.0.2
[CC1]	Common Criteria for Information Technology Security Evaluation, Part 1: Introduction and general model. Version 3.1. Revision 3. July 2009. CCMB-2009-07-001.
[CC2]	Common Criteria for Information Technology Security Evaluation, Part 2: Security functional requirements. Version 3.1. Revision 3. July. CCMB-2009-07-002.
[CC3]	Common Criteria for Information Technology Security Evaluation, Part 3: Security assurance requirements. Version 3.1. Revision 3. July 2009. CCMB-2009-07-003.
[CEM]	Common Methodology for Information Technology Security Evaluation, Evaluation Methodology. Version 3.1. July 2009. CCMB-2009-07-004.
[CPESC]	CCDB, Composite product evaluation for Smart Cards and similar devices, September 2007, Version 1.0 - Revision 1, September 2007, CCDB-2007-09-001
[MC-PayPass]	Mobile MasterCard PayPass – Mchip4 v1.0 April 2010 MasterCard - PayPass M/CHIP – version 13, September 2005
[DCSSI2741]	Règles et recommandations concernant le choix et le dimensionnement des mécanismes cryptographiques de niveau de robustesse standard N° 2741/SGDN/DCSSI/SDS/LCR Version 1.10
[GUIDE]	<ul style="list-style-type: none"> - Mobile Paypass 1.0 on UpTeq NFC2.0.4_OFM Preparation Guidance. Ref: PRE_D1270296 (1.01). - Mobile Paypass 1.0 on UpTeq NFC2.0.4_OFM Guidance for administration. Ref: OPE_D1270295 (1.01). - Mobile MasterCard Paypass Card Applications V1.0, Installation Guide Ref: D2148603 (MobilePayPassInstallGuide.pdf)

	Reference D1270292	Release 1.01p <small>(Printed copy not controlled: verify the version before using)</small>
	Classification level Public	Pages 133

References	Description
	<ul style="list-style-type: none"> - Mobile MasterCard Paypass Card Applications V1.0, Administration Guide Ref: D2148601 (MobilePayPassAdminGuide.pdf) - Mobile MasterCard Paypass Card Applications V1.0, Developing Client Applications Guide Ref: D2148602 (MobilePayPassDevClientAppsGuide.pdf)
[NFC-ST]	UpTeq NFC2.0.4_OFM Security Target. Ref: ST_D1255596 (1.2).
[NFC-GUIDE]	<ul style="list-style-type: none"> - UpTeq NFC 2.0.4_OFM Preparation Guidance for Personalization by Morpho Ref: PRE_D1263509 (1.3) - UpTeq NFC 2.0.4_OFM Guidance for Administration (M-NFC 2.0 platform with CA and Optional VA). Ref: OPE_D1224697_w_CA (1.3) - UpTeq NFC 2.0.4_OFM OPE annex. Ref: D1263600 - OPE-Annex – OFM (1.4) - Guidance for Verification Authority of Orange NFC V2 G1 card. Ref: OPE_D1226483v (1.5) - Rules for applications on a Upteq M-NFC certified product Ref: D1186227 (A09.2) - Guidance_for_secure_application_development_on_Upteq_mNFC Ref: D1188231 (A07) - UpTeq Card Architecture Guide with GP2.2 Ref: D1189324 - UpTeq Card APDU Guide Ref: D1189337 - UpTeq Applet Development Guide Ref: D1110140 - Connection Over CAT_TP/BIP v2.0.1 Technical Specifications Guide Ref: D1111478 - UpTeq_OTA Messaging Guide Ref: D1172819 - UpTeq m-NFC 2.0_User's Guide Ref: D1187335

1.4 Definitions

Please refer to Part I: “Product Definition” [PM-1] – Section 2.5.

	Reference D1270292	Release 1.01p <small>(Printed copy not controlled: verify the version before using)</small>
	Classification level Public	Pages 133

1.5 Acronyms and Abbreviations

Please refer to Part I: “Product Definition” [PM-1] – Section 2.6.

Abbreviations	Meaning
AAC	Application Authentication Cryptogram
AFL	Application File Locator
AID	Application IDentifier
APDU	Application Protocol Data Unit
API	Application Programming Interface
ARPC	Authorisation Response Cryptogram (within a transaction)
ARQC	Authorisation Request Cryptogram (within a transaction)
ATC	Application Transaction Counter
CAS	Common Approval Scheme
CC	Common Criteria
CDOL	Card risk management Data Object List
CEM	Common Evaluation Methodology
CVM	Card Verification Method
CVR	Card Verification Results
DDA	Dynamic Data Authentication
DDOL	Dynamic Data Object List
EAL	Evaluation Assurance Level
EMV	Europay MasterCard Visa
ETR_COMP	Report for a composite Smart Card Evaluation
GP	Global Platform
IC	Integrated Circuit
IT	Information Technology

	Reference D1270292	Release 1.01p <small>(Printed copy not controlled: verify the version before using)</small>
	Classification level Public	Pages 133

Abbreviations	Meaning
JCS	Java Card System
JSR	Java Specification Request
MMI	Man Machine Interface
MNO	Mobile Network Operator
NFC	Near Field Communication
OS	Operating system
OSP	Organizational Security Policy
OTA	Over The Air
PAN	Primary Account Number
PAP	Payment Application Package
PC	Personal Code
PIN	Personal Identification Number
POS	Point Of Sale
PP	Protection Profile
RSA	Rivest Shamir Adleman
SIM	Subscriber Identity Module
ST	Security Target
TOE	Target Of Evaluation
TSM	Trusted Service Manager
TSF	TOE Security Functions
USIM	Universal Subscriber Identity Module

	Reference D1270292	Release 1.01p <small>(Printed copy not controlled: verify the version before using)</small>
	Classification level Public	Pages 133

1.6 TOE overview

This section briefly describes the usage of the TOE and its major security features, identifies the TOE type and any non-TOE hardware/software/firmware required by the TOE.

1.6.1 TOE type

The product to be evaluated is Gemalto **Mobile PayPass 1.0 on UpTeq NFC2.0.4_OFM** (U)SIM module intended to be plugged in a mobile handset to provide secure payment services to an end user (see Figure 1).

The TOE is composed of the following bricks:

- A Gemalto **UpTeq NFC2.0.4_OFM** (U)SIM Java Card platform certified conformant to [PP USIM] which is a piece of software (OS, Java Card System, (U)SIM APIs, ...) embedded in an STMicroelectronics ST33F1M Integrated Circuit (IC). It shall be compliant with GlobalPlatform UICC¹ Configuration [GP-4] and GlobalPlatform Card Specification v2.2 [GP] including the extended ProcessData method as defined in Confidential Card Content Management (GP2.2 Card Specification v2.2 - Amendment A [GP-CCCM]). The (U)SIM also implements the mechanisms defined in GlobalPlatform Amendment C [GP-5].
- A Gemalto **Mobile PayPass v1.0** Payment Application Package² (PAP) compliant with [PM-1], [PM-2] and [PM-6].

¹ UICC stands for a (U)SIM card

² The term package doesn't correspond to the package in Java world but means the contactless mobile payment application

	Reference	D1270292	Release	1.01p (Printed copy not controlled: verify the version before using)
	Classification level	Public	Pages	133

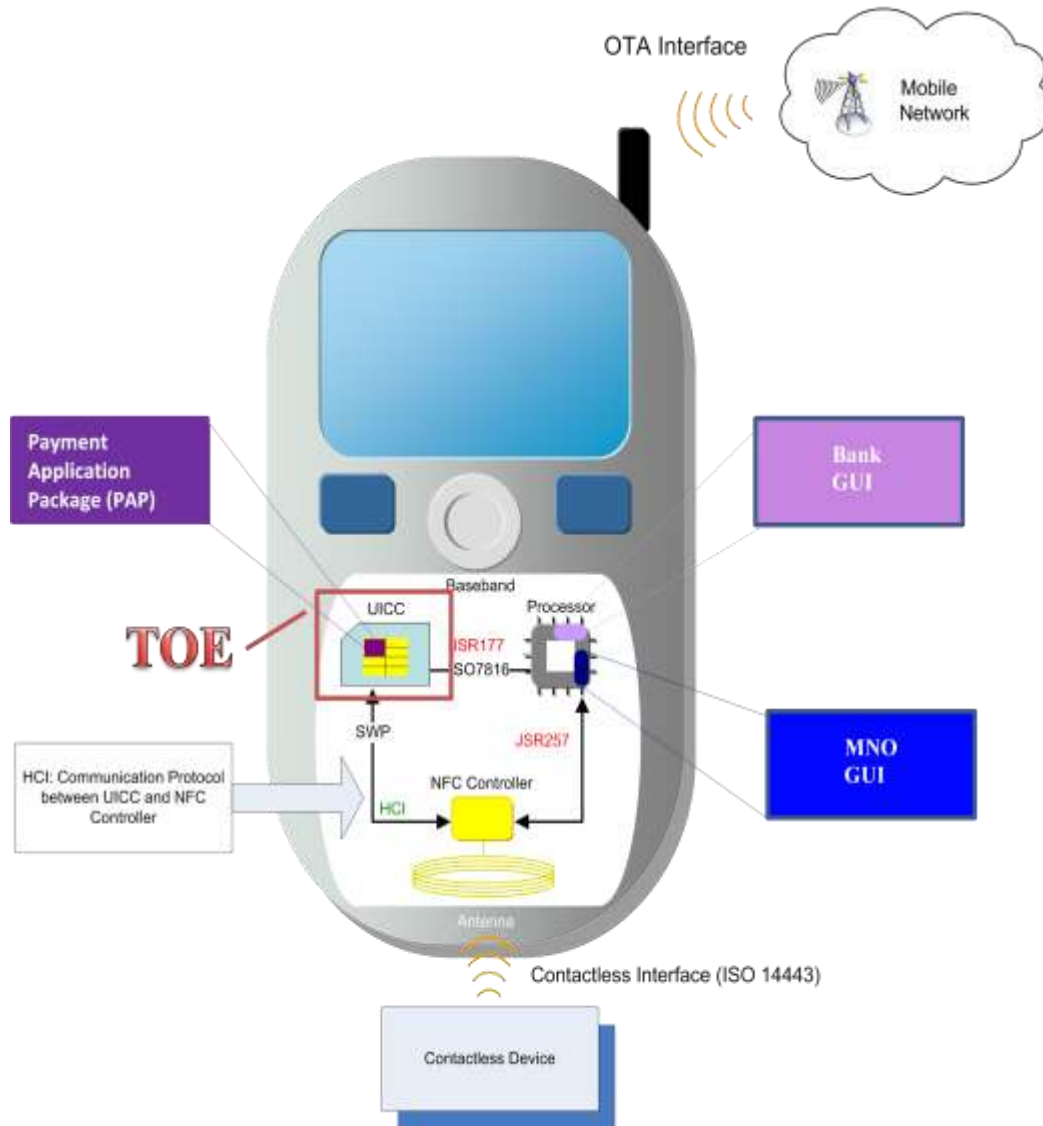

Figure 1: TOE type

The PAP application shall be compliant to the MasterCard [PM-6] Payez Mobile Implementation Guide.

For MasterCard, PAP is composed of:

- the Contactless Mobile Payment application or CMP application, defined section 1.7.1.1;
- the Payez Mobile Customization Package.

1.6.2 Usage and major security features of the TOE

Refer to the §1.3.2 of [NFC-ST] for usage of the platform.

Payez Mobile introduces an innovative Contactless Mobile Payment (CMP) solution that enables CMP transactions via radio frequency with the payment function located on a mobile handset supporting NFC technologies.

	Reference D1270292	Release 1.01p <small>(Printed copy not controlled: verify the version before using)</small>
	Classification level Public	Pages 133

One or more PAP can be installed in the (U)SIM module. To execute a CMP, customers simply hold their mobile handset close to a contactless reader to exchange payment information. Authorization and clearing are processed similarly to an EMV or a magnetic stripe purchase transaction. The *Payez Mobile* solution can be used for any transaction amount, including low value transactions. *Payez Mobile* CMP is characterized by a radio frequency short read range distance that requires the mobile handset to be presented close to the contactless reader to enable a transaction. Thus, only proximity purchase transactions are authorized ([PM-1], Section 4.2).

Two modes are offered to a customer to execute a *Payez Mobile* CMP: Mode 1 “PIN – TAP” and Mode 2 “TAP – PIN – TAP”.

Warning:

The acronym PIN used in the two payment modes described below refers to the Personal Code provided by the Issuing Bank to the customer.

	Reference	D1270292	Release	1.01p (Printed copy not controlled: verify the version before using)
	Classification level	Public	Pages	133

1.6.2.1 Mode 1: PIN – TAP

When making a purchase, first, the customer manually chooses the appropriate PAP to be used for the purchase transaction, enters his Personal Code then taps his mobile handset on the landing zone of the POS terminal³ to submit a payment transaction with the amount requested by the merchant and indicated on the POS terminal. Figure 2 illustrates this mode of payment transaction in seven steps.

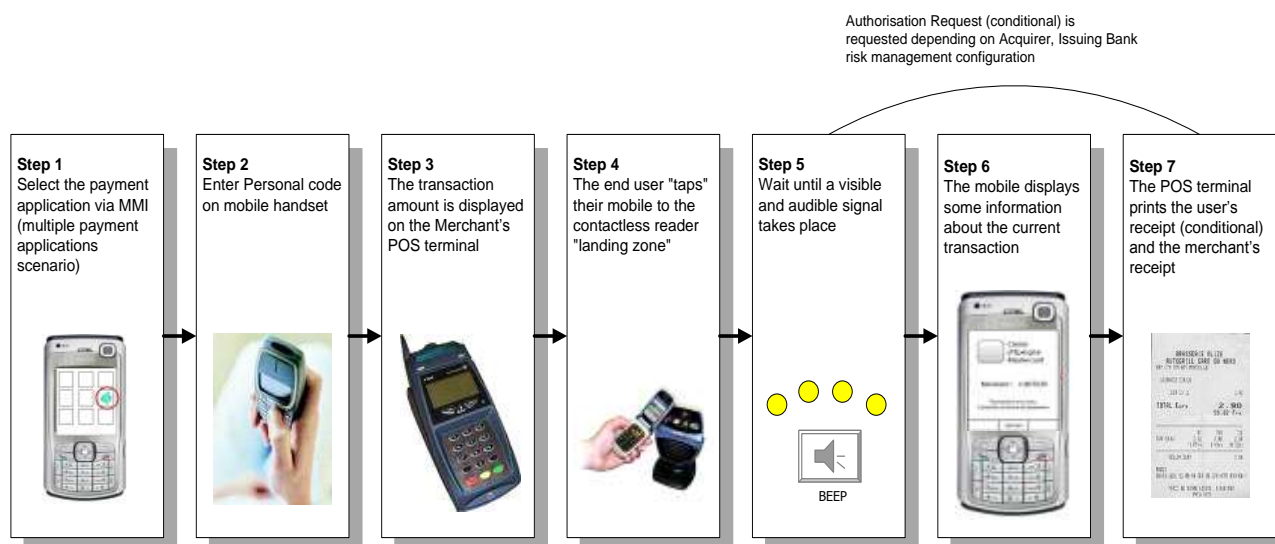



Figure 2: Mode 1: PIN - TAP

1.6.2.2 Mode 2: TAP – PIN – TAP:

In this mode, the customer first taps his mobile to the landing zone of the POS terminal which already displays a transaction amount; after that, if the transaction amount is lower than Personal Code Entry Limit (e.g. 20 EUR) then the transaction is processed without Personal Code (optional upon customer configuration). Otherwise, if the amount is above the Personal Code Entry Limit (see Personal Code Entry Conditions listed in Section 4.5.2.1, [PM-1]), then the customer enters his Personal Code and after that taps his mobile handset a second time on the landing zone of the merchant POS terminal in order to proceed with the payment transaction. The steps of this mode of transaction are presented in Figure 3.

³ Point of sales (POS) stands for the merchant acceptance terminal used to execute and process a financial transaction by communicating with a customer device such as a mobile handset. POS terminal includes stand alone, multi-lanes or ECR devices. The POS incorporates a contactless interface device and may also include other components and interfaces.

	Reference	D1270292	Release	1.01p (Printed copy not controlled: verify the version before using)
	Classification level	Public	Pages	133

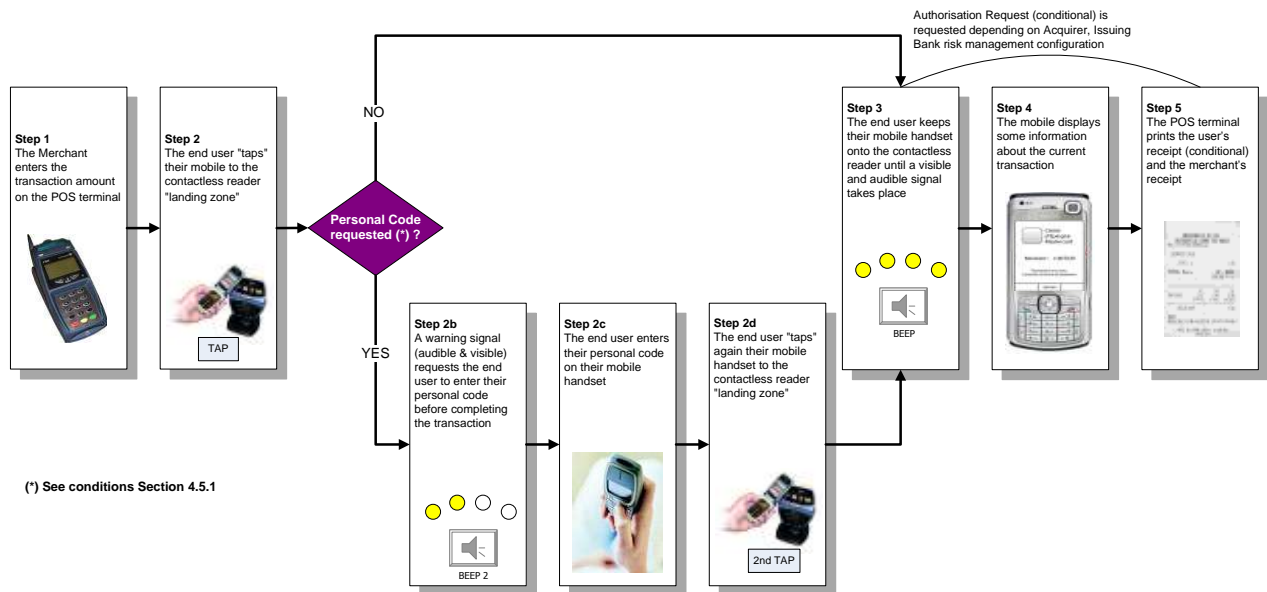

Figure 3: Mode 2 - TAP - PIN – TAP

1.6.2.3 Security features

In addition to the security functions supported by the (U)SIM platform, (refer to the §1.3.8 of [NFC-ST] for usage of the platform) , the PAP shall support the security features listed below:

- Offline communication with the POS terminal
- Offline Data Authentication
- Online Authentication and communication with the Bank Issuing
- Personal Code verification and management
- Transaction risk management analysis
- Transaction Certification
- Counter reset processing,
- Script processing via OTA bearer
- Auditing
- Log reading and update
- Administration management (Contactless life cycle management)

Depending on the Acquirer and Issuing Bank risk management configuration, the merchant POS terminal processes the proximity purchase transaction offline or online.

A *Payez Mobile* CMP transaction shall be executed according to *Payez Mobile* specification and under MasterCard, Visa or local scheme requirements and operating rules and should use the same authorization network and clearing system than standard credit and debit cards. The contactless payment application targeted is the Mobile PayPass v1.0 application according to MasterCard specifications.

1.6.3 Required non-TOE hardware/software/firmware

This action describes the hardware, software or firmware present in the environment of the TOE and that are required to have a functional correct usage of the TOE.

For a detailed description, see [PM-2], Section 2.2.

	Reference D1270292	Release 1.01p <small>(Printed copy not controlled: verify the version before using)</small>
	Classification level Public	Pages 133

The non-TOE hardware/software/firmware required by the (U)SIM platform (e.g. Bytecode verifier) are also required by the TOE. More precisely all applications must follow the rules given inside guidances for Upteq M-NFC certified product (D1186227 & D1188231).

Next paragraphs below describe the items required in the environment of the product but not required for secure usage of the TOE.

1.6.3.1 Payez Mobile Application⁴ (AEPM CREL Application)

The *Payez Mobile* application is a CREL (Contactless Registry Event Listener) application according to Global Platform Amendment C [GP-5]. The *Payez Mobile* application applies the *Payez Mobile* business logic consisting to have only one activated Payment Application Package at a time. Upon a new activation request, this application is responsible for managing the deactivation of the current activated payment application.

The *Payez Mobile* application is the single application (except the CMP application itself) that can modify the CMP contactless life cycle state from “ACTIVATED” to “DEACTIVATED”.

This application does not apply its business logic if the new application to be activated and the current activated application are members of the same application group, or in case of one-shot payment⁵.

1.6.3.2 Proximity Payment System Environment (PPSE) application (EMVCo CREL Application)

The PPSE application is a CREL (Contactless Registry Event Listener) application according to GlobalPlatform Amendment C [GP-5].

This application is present in the Issuer Security Domain. Therefore, it is under the MNO’s responsibility.

Its role is to:

- read the GP Registry in order to check the “ACTIVATED” CMP application. Only one CMP application is in the state “ACTIVATED” at a time. Therefore, the PPSE contains only one CMP application AID;
- build the “SELECT PPSE” response. The PPSE response is updated each time an activation or deactivation notification is received from the CRS API (Contactless Registry Service Application Programming Interface);
- upon reception of a “SELECT PPSE” command, the PPSE application returns the PPSE response built previously.

1.6.3.3 Payment Bridge application

The Payment Bridge application is to allow a MIDlet to interact with a Mobile Paypass 1.0 banking application. Installed in a NFC-enabled UICC, its role is to manage the interactions with a MIDlet and the Payment application through ShareableInterface.

With an event initiated by the user or by the OTA server, the Service Provider’s MIDlet will be in measure to interact with the applets by sending APDUs through the I/O channel of the SIM. APDUs sent to the SIM will be controlled by the JSR177 layer of the handset. Within the SIM, the Payment Bridge applets act as a proxy between the Service Provider MIDlet on one side, and the payment application on the other side.

⁴ Not to be confused with the Payment Application Package (PAP).

⁵ One-shot payment : The CMP application (that is not active by default) selected by the Customer is used only for the current payment transaction.

	Reference D1270292	Release 1.01p <small>(Printed copy not controlled: verify the version before using)</small>
	Classification level Public	Pages 133

1.6.3.4 Bank TSM

This is a platform providing functions for transport encryption to manage the Bank Supplementary Security Domain (Bank SSD) by establishing a dedicated secure channel for management commands and data.

When using Delegated Management (DM) mode, it also provides functions to manage the request of SSD creation and after requesting a token DM to the MNO, to manage the payment application installation, instantiation and deletion.

1.6.3.5 UICC Management Platform

The UICC Management Platform is owned by the MNO and handles the global management of the customer's UICCs. This platform is mainly used during the payment service delivery.

1.6.3.6 Bank GUI Management Platform

The Bank GUI Management Platform enables the Bank GUI installation, its synchronization and its update. This platform shall be able to cover application portability issues and deliver the appropriate version of the Bank GUI, depending on the mobile handset used by customer.

1.6.3.7 POS terminal

Point of sales (POS) stands for the merchant acceptance terminal used to execute and process a financial transaction by communicating with a customer device such as a mobile handset.

POS terminal includes stand alone, multi-lanes or ECR devices The POS incorporates a contactless interface device and may also include other components and interfaces

The POS terminal shall comply with *Payez Mobile* minimum requirements defined in [PM-2].

1.6.3.8 POS Application

The POS terminal hosts a payment application that complies with MasterCard (PayPass), Visa (PayWave) or local scheme contactless specifications and with *Payez Mobile* Specifications.

1.6.3.9 Mobile Handset

The TOE as a smartcard is intended to be plugged in a mobile handset. This equipment can be a mobile phone or a PDA or any other connecting device.

NFC Mobile handset shall comply with *Payez Mobile* minimum requirements defined [PM-2].

1.6.3.10 Bank GUI

The Bank GUI (Java, SDK Android...) is a graphical interface loaded into the mobile handset that allows the customer to access to the functions associated to their CMP applications.

The Bank GUI gives several functionalities to the customer for example:

- payment;
- set to ACTIVATED by default (Activate its CMP application);
- deactivate its CMP application;
- change the Personal Code;
- change the application name;
- CMP application parameters update;
- transaction log consultation;
- etc.

	Reference D1270292	Release 1.01p <small>(Printed copy not controlled: verify the version before using)</small>
	Classification level Public	Pages 133

1.6.3.11 MNO GUI

The MNO GUI is the primary graphical interface loaded onto the mobile handset which allows the customer to access all their NFC services stored in the UICC.

If the customer selects one PAP, the MNO GUI launches the associated graphical interface (called Bank GUI).

This interface allows the Customer to identify the current active CMP application by displaying a logo beside the associated Bank GUI.

1.6.3.12 OTA Platform

Platform using OTA mechanisms providing functions to tunnel information messages exchanged between the UICC Management Platform or the Bank TSM and a (U)SIM.

1.7 TOE description

1.7.1 Physical scope of the TOE: all hardware, firmware, software and guidance

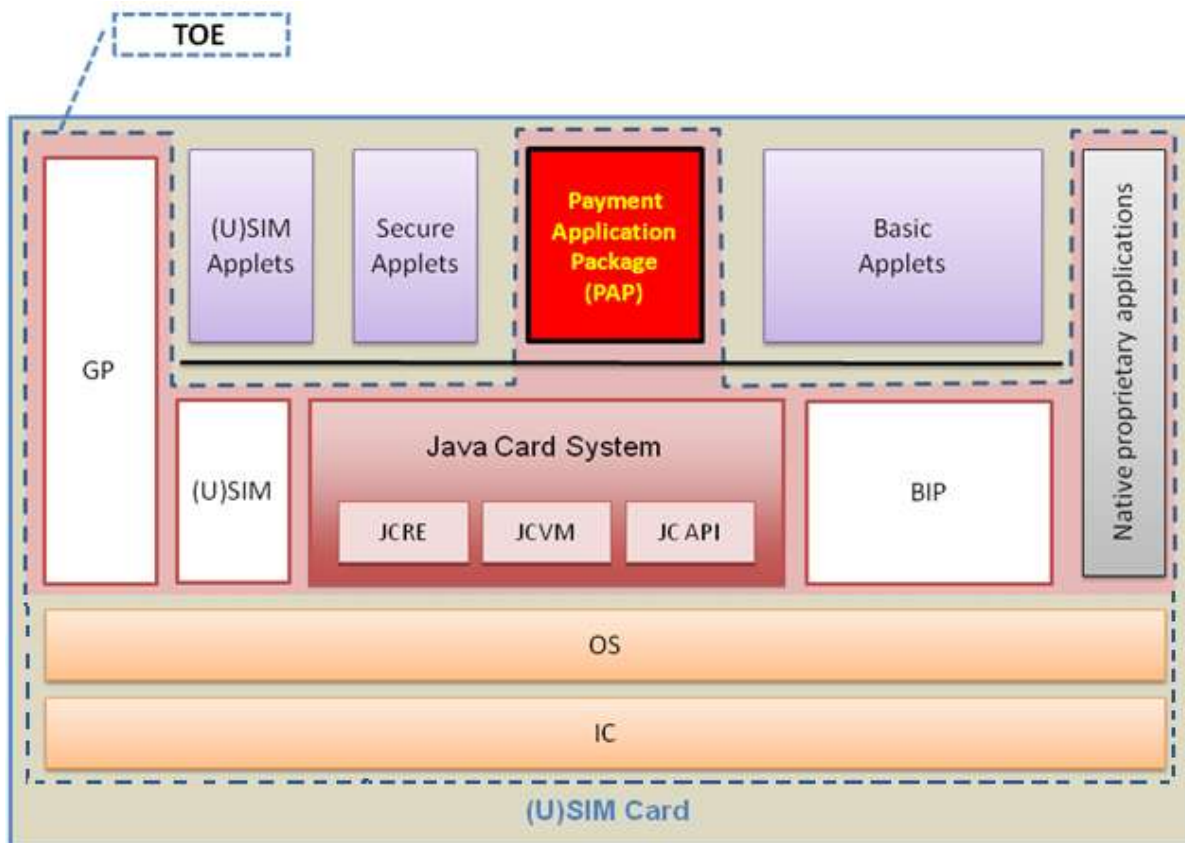



Figure 4: TOE physical scope like in [PAP]

	Reference D1270292	Release 1.01p <small>(Printed copy not controlled: verify the version before using)</small>
	Classification level Public	Pages 133

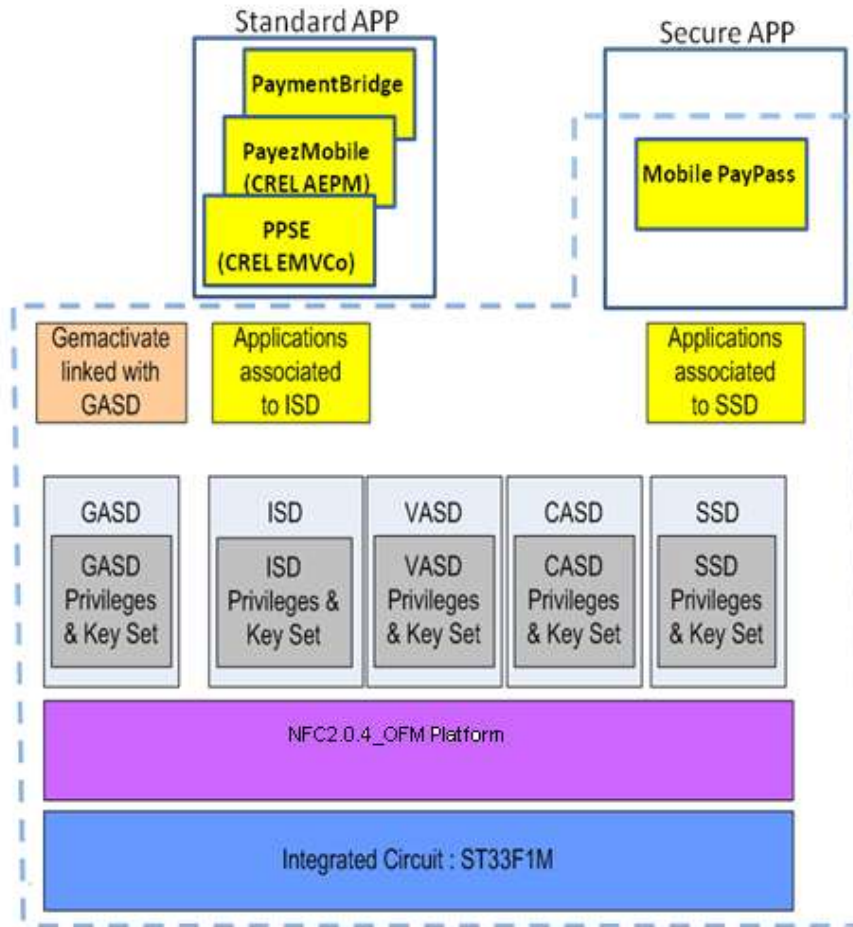



Figure 5: TOE logical boundaries

	Reference	D1270292	Release	1.01p <small>(Printed copy not controlled: verify the version before using)</small>
	Classification level	Public	Pages	133

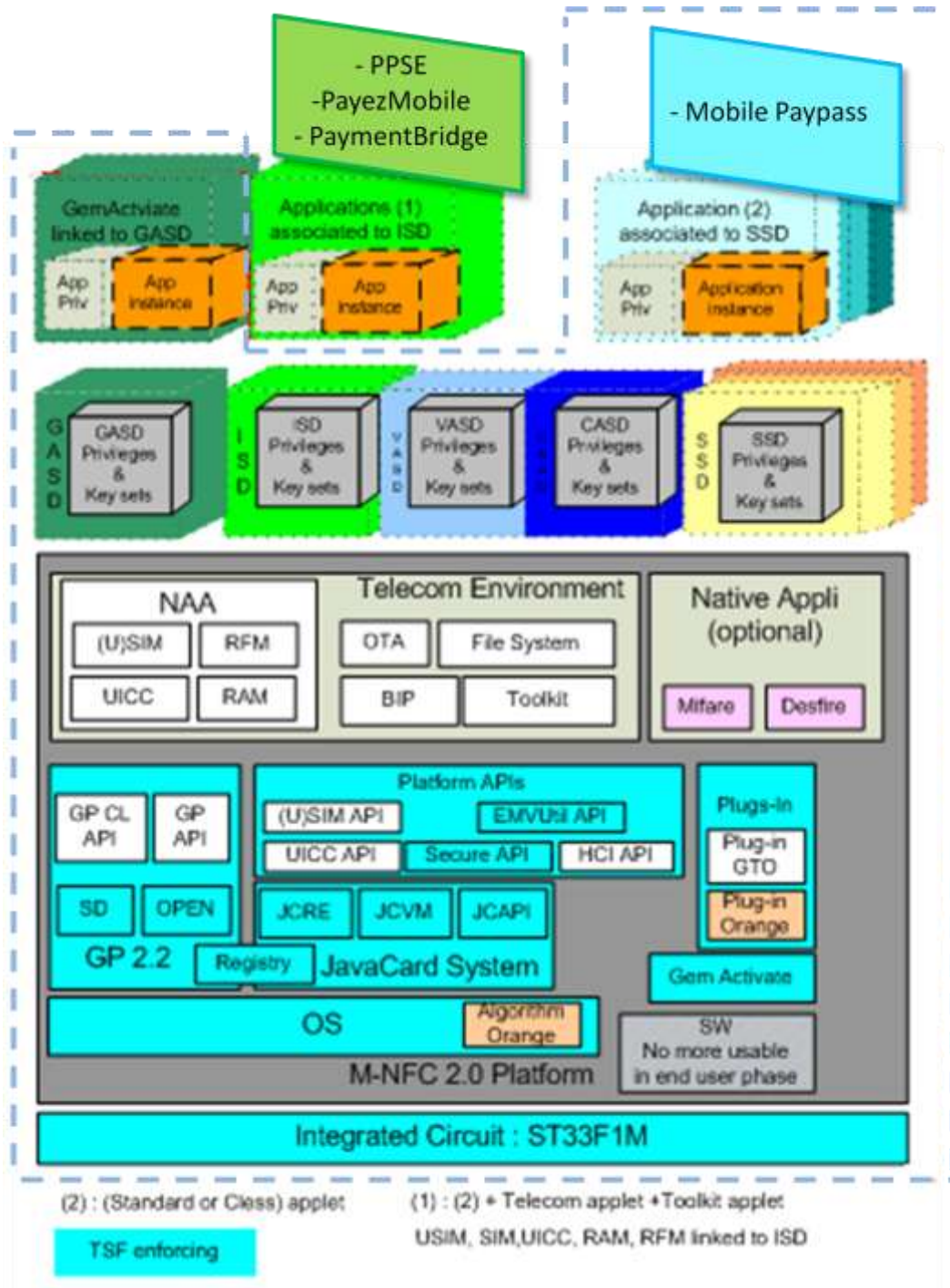



Figure 6: Major TOE items and scope

The physical interfaces are those described in the platform ST [NFC-ST].

	Reference D1270292	Release 1.01p <small>(Printed copy not controlled: verify the version before using)</small>
	Classification level Public	Pages 133

The following platform TOE components are described in details in the the platform ST [NFC-ST] §1.3.3 and §1.3.5 compliant to the (U)SIM platform Protection Profile [PP USIM]:

- **ST33F1M** Integrated Circuit (IC) or chip
- **NFC2.0** (U)SIM
- Bearer Independent Protocol (BIP) that does not offer any security function for the TOE
- Java Card System according JCS Protection Profile [JCS PP] Open configuration
- GlobalPlatform (GP)
- Native proprietary applications

1.7.1.1 Payment Application Package (PAP)

The Payment Application Package is loaded on a Bank TSM (cf. [PM-6]).

The **Mobile Paypass 1.0** CMP application is compliant with the payment scheme specifications:

- MasterCard PayPass specifications (MChip/MagStripe)

It is possible to have several versions of the same CMP application loaded onto the UICC and thus several instance versions.

In our case the Mobile Paypass 1.0 is loaded on a Bank SSD.

For more details about the PAP Application, please refer to:

- Section 1.7.2 of this document;
- *Payez Mobile* MasterCard Implementation Guide [PM-6].

	Reference D1270292	Release 1.01p <small>(Printed copy not controlled: verify the version before using)</small>
	Classification level Public	Pages 133

1.7.2 Logical scope of the TOE: the logical security features offered by the TOE

Refer to the §1.3.8 of [NFC-ST] for description of platform security features.

This section describes the security features offered by the PAP. These are structured in several modules (see Figure 7). For a detailed description about these modules, refer to [PM-6] section 2.1.

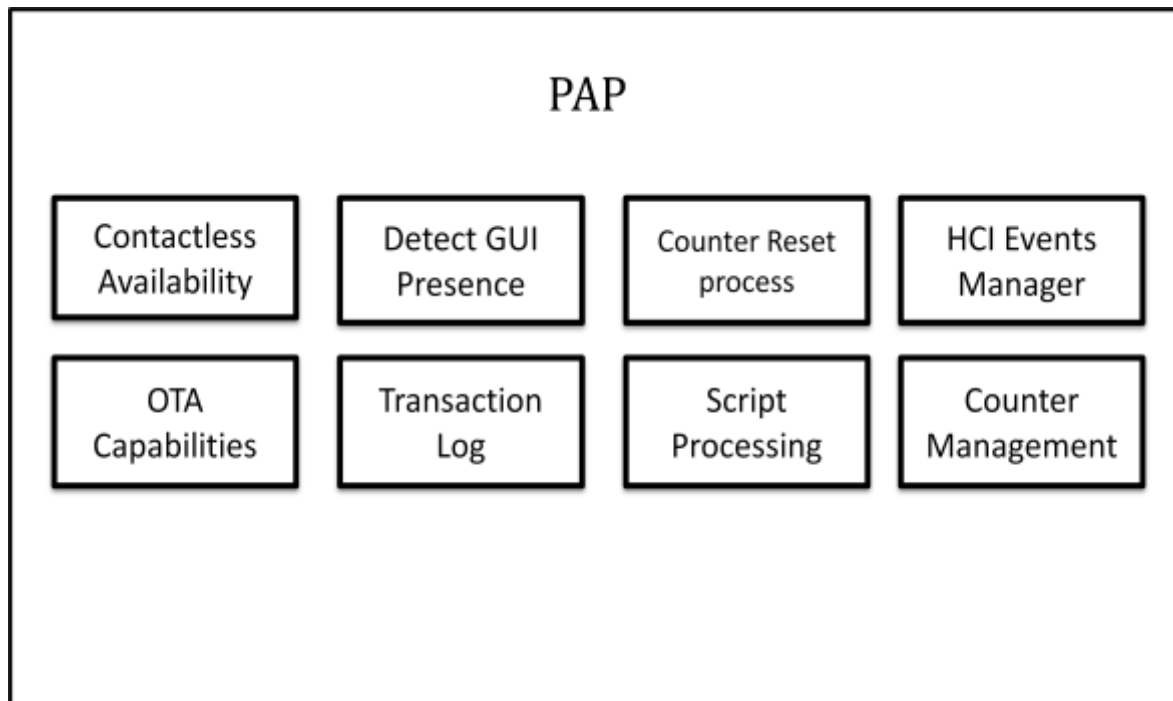

Figure 7: PAP Module

1.7.2.1 Contactless Availability

The contactless availability is responsible for:

- the CMP activation by using the activation interface of the CRS API (the contactless life cycle state will be updated to the value 'ACTIVATED' in the GP Registry)
- the CMP deactivation by using the deactivation interface of the CRS API (the contactless life cycle state will be updated to the value 'DEACTIVATED' in the GP Registry)
- the CMP blocking by setting up the contactless life cycle state to the value 'NON ACTIVATABLE' in the GP Registry (using the CRS API).

1.7.2.2 Script Processing Module

This is a functional module allowing the Issuing Bank to update some parameters of the application and strictly compliant with the payment scheme specifications.

This module supports Personal Code Change/Unblock command, Personal Code Entry Limit Update, etc.

For a detailed description about the Script Processing Module, refer to [PM-2], section 8.3.

	Reference D1270292	Release 1.01p <small>(Printed copy not controlled: verify the version before using)</small>
	Classification level Public	Pages 133

1.7.2.3 Counters Management

This module enables the update of limits and counters partial renewal. The offline counters are updated during a payment transaction if it is accepted offline. The counters are not updated if a transaction is completed online.

1.7.2.4 Counter Reset Processing Module

This module ensures that the CMP application counter limit is not exceeded. When counters exceed their limit, the CMP application requests an online authorization to finalize the transaction.

For more information about this process, please refer to [PM-2] Section 8.2.4, [PM-6].

1.7.2.5 Transaction Log Module

During a payment transaction, this module ensures that the data for the transaction are logged. Moreover, it allows the Bank GUI to retrieve the transaction log data for display purposes.

1.7.2.6 Detect GUI Presence Module

This module enables to detect the presence of the Bank GUI. If the Bank GUI is not present, the transaction cannot be executed.

1.7.2.7 HCI Events Manager Module

The HCI events are used to wake up the Bank GUI when a user interaction is required (at the end of a transaction or when the Personal Code is required)⁶.

1.7.2.8 Over-The-Air (OTA) Capabilities

Platform using OTA mechanisms providing functions to tunnel information messages exchanged between the UICC Management Platform or the Bank TSM and a (U)SIM.

⁶ The only HCI event used in *Payez Mobile* solution is the EVT_TRANSACTION without the use of the parameter field. To be aware of the transaction context (i.e. why the Bank GUI has be awoken), the Bank GUI shall read the Mobile Cardholder Interaction Information

	Reference	D1270292	Release	1.01p <small>(Printed copy not controlled: verify the version before using)</small>
	Classification level	Public	Pages	133

1.7.3 Overview of the TOE Life Cycle

The life cycle of the TOE is the life cycle of the (U)SIM card ((U)SIM Platform + PAP), from the development to the operational stage through manufacturing and personalization. Figure 8 illustrates the life cycle of the (U)SIM Platform as well as the life cycle of the PAP.

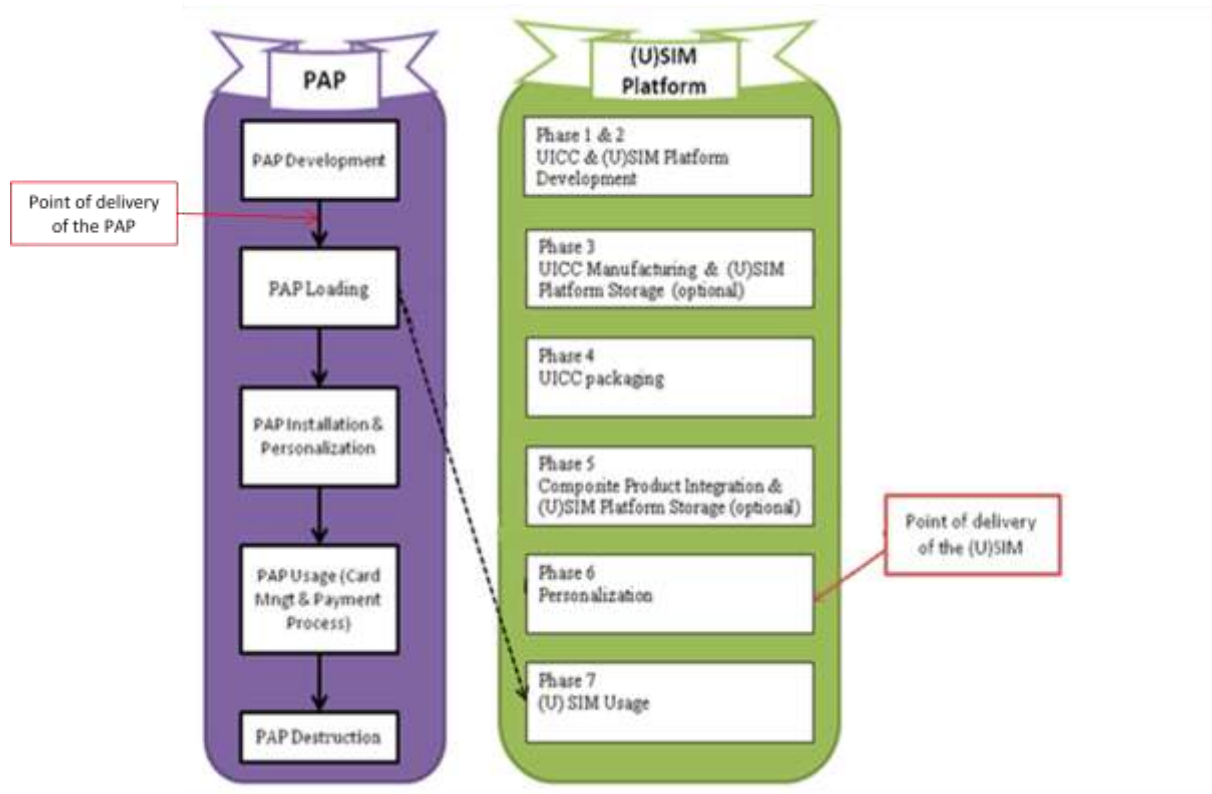



Figure 8: TOE life cycle overview

We refer to platform ST [NFC-ST] for the definition of the (U)SIM Platform life cycle. The personalization phase (phase 6) includes the loading in pre-issuance of the 3 Standards APP according to the product configuration (i.e. **PPSE**, **Payez Mobile** and **Payment Bridge**).

The life cycle of the PAP consists of consecutive stages:

- **Development:** This stage is performed on behalf of the Issuing Bank in a secure development environment;
- **Loading:** This stage may occur in phase 7. Loading in Phase 7 is post-issuance, e.g. using OTA means;
- **Installation & Personalization:** This stage may occur in phase 7 in the usage environment;
- **Usage:** This stage occurs in phase 7. In PAP Usage phase, the MNO and/or the Issuing Bank may perform card management and PAP management activities such as updating parameters, PAP blocking/unblocking, etc;
- **Destruction:** At this stage, the PAP is destroyed.

We refer to platform Guides [NFC-GUIDE] for the security recommendations to apply.

	Reference	D1270292	Release	1.01p <small>(Printed copy not controlled: verify the version before using)</small>
	Classification level	Public	Pages	133

From figure 8 and [NFC-ST] figure 5, the TOE life cycle is the following:

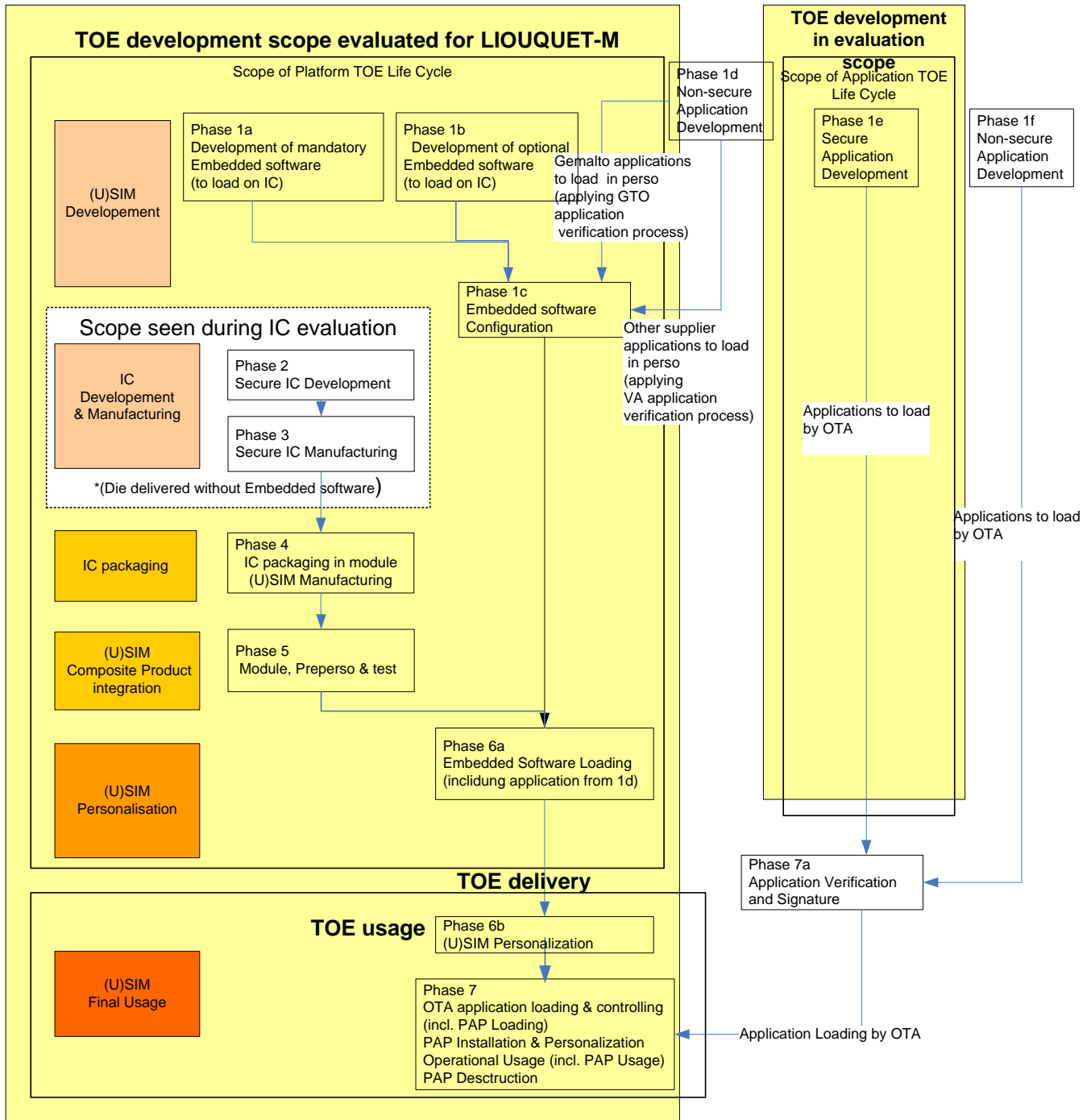



Figure 9: TOE life cycle

Phase 6b is the embedding in card body and personalization. This phase is out of the evaluation scope.

	Reference D1270292	Release 1.01p <small>(Printed copy not controlled: verify the version before using)</small>
	Classification level Public	Pages 133

PAP development (phase 1) is in the TOE evaluation scope, including the application verification according to rules given inside guidances for Upteq M-NFC certified product (D1186227 & D1188231). PAP verification and signature by Verification Authority (VASD) prior to PAP loading (phase 7) is out of the TOE evaluation scope (covered by the platform guidance).

The **Mobile Paypass 1.0** application, Secure APP, is loading in post-issuance during PAP loading phase (phase 7).

1.7.3.1 TOE role and environment

We refer to platform ST [NFC-ST] for the location of the (U)SIM Platform role and environment.

Stage	Role and Environment
PAP development	<p>PAP Application Developer for Issuing Bank.</p> <p>Gemalto Meudon, 6 rue de la Verrerie, 92197 Meudon.</p> <p>Gemalto La Ciotat, La Vigie – Avenue du Jujubier – ZI Athélia IV, 13705 La Ciotat.</p> <p>Gemalto Singapore, 12 Ayer Rajah Crescent, 139941 Singapore.</p> <p>ITSEF</p> <p>Secure environment.</p>
PAP loading	<p>Application loader (i.e. TSM⁷ entity) is in charge of secure application loading. The TSM-SP acting behalf Issuing Bank (SSD) to load the secure applications by OTA. The TSM-SP is composed of Integrator to setup the server and the Server (that contains secure application/DAP and software with required keys) to perform the loading.</p> <p>Before loading, all applications are verified by a Validation Laboratory for the Standard applications, or by ITSEF for the Secure applications.</p> <p>All applications are associated at load time to a Verification Authority⁸ signature (Mandated DAP) that is verified on-card by the on-card representative of the VA prior to the completion of the application loading operation and prior to the instantiation of any applet defined in the loaded application.</p> <p>Controlling Authority⁹</p>
PAP installation and personalization	<p>PAP Provider¹⁰ (Issuing Bank / SSD) personalize their applications and security domains in a confidential manner.</p>

⁷ TSM means Trusted Services for Mobile NFC by linking MNO with the NFC world, managing services for banks and transport operators and always-on services backed by banking grade security. Several TSM exist: the TSM-SP acting on behalf the Service Provider (ie. Bank) and TSM-MNO acting on behalf the MNO (ie. Orange).

⁸ The Verification Authority (VA), trusted third party represented on the (U)SIM card, acting on behalf of the MNO and responsible for the verification of applications signatures (mandated DAP) during the loading process. These applications shall be validated for the standard applications or certified for the secure ones.

⁹ The Controlling Authority (CA), entity independent from the MNO represented on the (U)SIM card and responsible for securing the keys creation and personalization of the Application Provider Security Domain (APSD).

	Reference D1270292	Release 1.01p <small>(Printed copy not controlled: verify the version before using)</small>
	Classification level Public	Pages 133

	<p>They have security domain keysets enabling them to be authenticated to the corresponding security domain and to establish a trusted channel between the TOE and an external trusted device. These security domain keysets are not known by the (U)SIM Card issuer.</p>
PAP usage (Card Mngt & Payment process)	<p>(U)SIM Card issuer (Orange MNO¹¹ / ISD) is initially the only entity authorized to manage applications (loading, instantiation, deletion) through a secure communication channel with the card, based on SMS or BIP technology. However he can grant these privileges to the PAP Provider through the delegated management function of GP.</p> <p>PAP Provider (Issuing Bank / SSD).</p> <p>End User</p> <p>Unprotected environment.</p>
PAP destruction	<p>PAP Provider (Issuing Bank / SSD).</p> <p>Unprotected environment.</p>

1.7.4 PAP on-card life cycle

The on-card life cycle of the PAP (see Figure 11: GP standard life cycle states) is compliant with the GlobalPlatform standard life cycle [GP]:

The PAP life cycle is divided in two parts:

- The contactless life cycle, concerning the contactless PAP states
- The life cycle status, concerning the standard GP states

1.7.4.1 Contactless life cycle

The contactless life cycle is composed of three states:

- **ACTIVATED** state in which the application is activated and can be selected by a terminal application;
- **DEACTIVATED** state in which the application is deactivated but still can be selected by a terminal application to receive appropriate commands. For instance, in this state, the customer is authorized to view his transactions log or change the Personal Code;
- **NON-ACTIVATABLE** state in which the application cannot be activated and its services are blocked either by the Issuing Bank or as a result of several (above the Personal Code Entry Limit) wrong Personal Code entry by the customer. When the life cycle status of the “Head Application” of an application group is NON ACTIVATABLE, then the members of the application group are automatically deactivated (application life cycle state changed to the value “DEACTIVATED”). Please refer to GlobalPlatform [GP] for more information.

¹⁰ The Application Provider (AP) of PAP, financial institution (a bank) responsible for the applications and their associated services.

¹¹ The Mobile Network Operator (MNO or mobile operator), issuer of the (U)SIM Java Card platform and proprietary of the (U)SIM. The platform guarantees that the issuer, once authenticated, could manage the loading, instantiation or deletion of applications.

	Reference	D1270292	Release	1.01p <small>(Printed copy not controlled: verify the version before using)</small>
	Classification level	Public	Pages	133

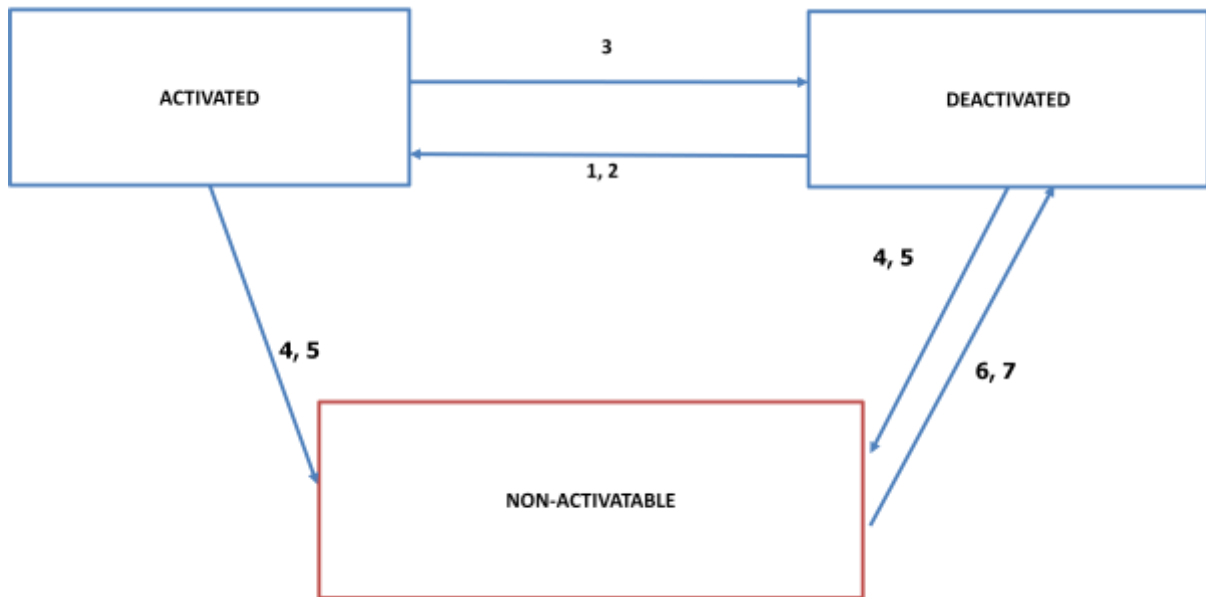

Figure 10: Contactless life cycle states

Steps Description:

1. Another CMP Application is ACTIVATED;
2. A Customer sets an application from “DEACTIVATED” to “ACTIVATED” via the function “Define a CMP application”
3. A Customer sets an application from “ACTIVATED” to “DEACTIVATED” via the function “Deactivate a CMP application”;;
4. The CMP application is blocked by the Issuing Bank (NON-ACTIVATABLE);
5. Three wrong personal codes have been entered by the Customer; the application is automatically blocked (NON-ACTIVATABLE). Personal Code unblock is required to unblock the CMP application;
6. The CMP Application is unblocked by the Issuing Bank;
7. The Personal Code is unblocked by the Issuing Bank.

1.7.4.2 GP standard life cycle

The life cycle status is the representation of the GP life cycle (compliant with [GP]).

The GP standard life cycle is composed of states:

- **INSTALLED** state corresponds to the status of the PAP after its installation. In this state, the PAP can also be personalized (for instance, with the Personal Code of the customer);
- **SELECTABLE** state that means that the Application is able to receive commands from off-card entities;
- **LOCKED** state which is a reversible state in which the PAP is NON SELECTABLE and its services are temporarily blocked.

	Reference	D1270292	Release	1.01p <small>(Printed copy not controlled: verify the version before using)</small>
	Classification level	Public	Pages	133

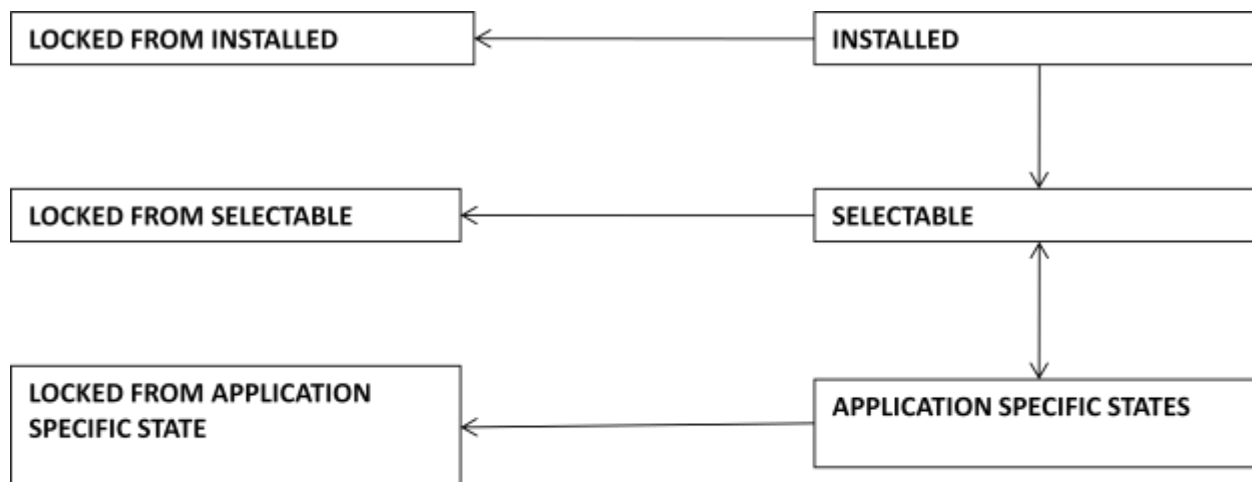

Figure 11: GP standard life cycle states

1.7.5 Configurations

Platform: UpTeq NFC2.0.4_OFM platform using ST33F1M

Configuration	Application			
	Mobile Paypass 1.0	PPSE	Payez Mobile	Payment Bridge
	(Mastercard)	(CREL EMVCo)	(CREL AEPM)	
	Bank SD	MNO ISD	MNO ISD	Bank SD
N°1 – Mastercard EMVCo	X (1 per virtual card)	X (1 instance)		
N°2 – AEPM France/WW	X (1 per virtual card)	X (1 instance)	X (1 instance)	
N°3 – Bridge	X (1 per virtual card)	X (1 instance)		X (1 per MPP)
N°4 – Bridge AEPM	X (1 per virtual card)	X (1 instance)	X (1 instance)	X (1 per MPP)

In our case:

- the **Mobile Paypass** 1.0 application is considered as Secure APP
- the **PPSE**, **Payez Mobile** and **Payment Bridge** applications are considered as Standard APP

	Reference D1270292	Release 1.01p <small>(Printed copy not controlled: verify the version before using)</small>
	Classification level Public	Pages 133

2 Conformance Claim

2.1 CC conformance claim

This Security Target is written using CC version 3.1 release 3.

This ST is CC Part 2 conformant and CC Part 3 conformant.

2.2 PP and Package claim

The evaluation assurance level of this security target is EAL4 augmented with:

- **ALC_DVS.2** Sufficiency of security measures
- **AVA_VAN.5** Advanced methodical vulnerability analysis

	Reference	D1270292	Release	1.01p <small>(Printed copy not controlled: verify the version before using)</small>
	Classification level	Public	Pages	133

3 Statement of compatibility

This section presents the statement of compatibility of the composite TOE (the PAP upon the (U)SIM platform). This statement stands as developer evidence of the composite evaluation activity ASE_COMP.1 defined in [CPESC]: “The aim of this activity is to determine whether the Security Target of the PAP does not contradict the Security Target of the underlying platform.”

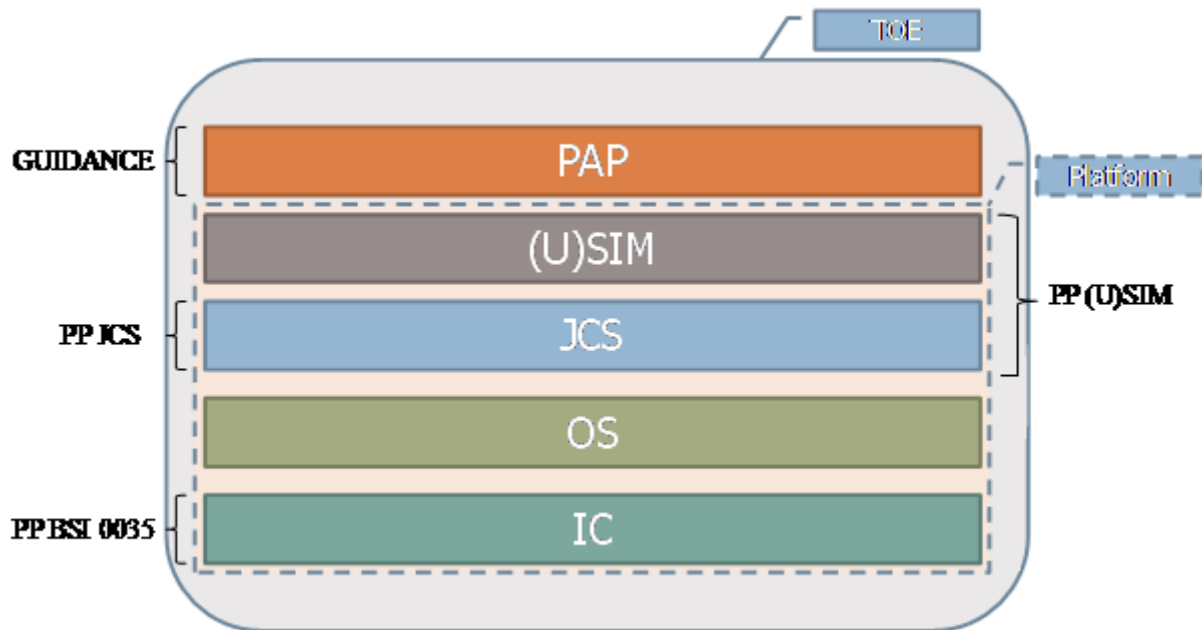



Figure 12: Conformance and Composition

The platform-ST is the **UpTeq NFC2.0.4_OFM platform** using ST33F1M given in [NFC-ST], compliant to the (U)SIM Protection Profile [PP USIM] Basic configuration.

The composite-ST is the **Mobile PayPass v1.0** given in present ST written from the AEPM's Guidance for Payment Application Package Security Target [PAP].

The platform-ST and composite-ST developer is **Gemalto**.

The next sections show by mapping from that there is not conflict between security environments (see §3.1, §3.2 and §3.3), security objectives (see §3.4 and §3.5) and security requirements (see §3.6, §3.7 and §3.8) of the composite-ST and platform-ST.

	Reference	D1270292	Release	1.01p <small>(Printed copy not controlled: verify the version before using)</small>
	Classification level	Public	Pages	133

3.1 Compatibility of threats

Platform-ST / (U)SIM Basic PP part	Composite-ST (T, not used, irrelevant)
T.PHYSICAL. The attacker discloses or modifies the design of the TOE, its sensitive data or application code by physical (opposed to logical) tampering means. This threat includes IC failure analysis, electrical probing, unexpected tearing, and DP analysis. That also includes the modification of the runtime execution of Java Card System, GlobalPlatform or SCP software through alteration of the intended execution order of (set of) instructions through physical tampering techniques.	All T.DISCLOSURE All T.INTEG
T.INTEG-USER-DATA. The attacker through a malicious applet loaded on the card modifies application data, application keys or authentication data.	All T.INTEG T.TEMPORARY_DATA
T.COM-EXPLOIT. An attacker remotely exploits the communication channel (USB, ISO-7816, NFC, BIP or SMS) established between the mobile phone and the (U)SIM card in order to modify or disclose confidential data.	All T
T.UNAUTHORIZED_CARD_MNGT. The attacker performs unauthorized card management operations (for instance impersonates one of the actor represented on the card) in order to take benefit of the privileges or services granted to this actor on the card such as fraudulent actions on package file, applet or security domain.	All T.DISCLOSURE All T.INTEG T.TEMPORARY_DATA All T.TRANSACTION T.APPLICATION_DOS All T.xxx_USURPATION
T.LIFE-CYCLE. An attacker accesses to an application outside of its expected availability range thus violating irreversible life cycle phases of the application (for instance, an attacker re-personalizes the application).	No contradiction.
T.UNAUTHORIZED_ACCESS. By using the shareable object mechanism on which relies the communication between two applets, the attacker uses an applet on card to get access or to modify data from another applet that he should not have access to.	No contradiction.
Platform-ST / JCS Open PP part	Composite-ST
T.CONFID-APPLI-DATA. The attacker executes an application to disclose data belonging to another application.	All T.DISCLOSURE
T.CONFID-JCS-CODE. The attacker executes an application to disclose the Java Card System code.	No contradiction.
T.CONFID-JCS-DATA. The attacker executes an application to disclose data belonging to the Java Card System.	No contradiction.
T.INTEG-APPLI-CODE. The attacker executes an application to alter (part of) its own code or another application's code.	All T.INTEG T.TEMPORARY_DATA (PAP code)
T.INTEG-APPLI-CODE.LOAD. The attacker modifies (part of) its own or another application code when an application package is transmitted to the card for installation.	(PAP code)

	Reference	D1270292	Release	1.01p <small>(Printed copy not controlled: verify the version before using)</small>
	Classification level	Public	Pages	133

T.INTEG-APPLI-DATA. The attacker executes an application to alter (part of) another application's data.	All T.INTEG T.TEMPORARY_DATA
T.INTEG-APPLI-DATA.LOAD. The attacker modifies (part of) the initialization data contained in an application package when the package is transmitted to the card for installation.	All T.INTEG T.TEMPORARY_DATA
T.INTEG-JCS-CODE. The attacker executes an application to alter (part of) the Java Card System code.	No contradiction.
T.INTEG-JCS-DATA. The attacker executes an application to alter (part of) Java Card System or API data.	T.INTEG_SEL_ACT_PARAM
T.SID.1. An applet impersonates another application, or even the Java Card RE, in order to gain illegal access to some resources of the card or with respect to the end user or the terminal.	T.INTEG_SEL_ACT_PARAM
T.SID.2. The attacker modifies the TOE's attribution of a privileged role (e.g. default applet and currently selected applet), which allows illegal impersonation of this role.	T.INTEG_KEYS T.INTEG_REG_PC T.INTEG_SEL_ACT_PARAM
T.EXE-CODE.1. An applet performs an unauthorized execution of a method.	(PAP code)
T.EXE-CODE.2. An applet performs an execution of a method fragment or arbitrary data.	(PAP code)
T.EXE-CODE-REMOTE. The attacker performs an unauthorized remote execution of a method from the CAD.	(PAP code)
T.NATIVE. An applet executes a native method to bypass a TOE Security Function such as the firewall.	No contradiction.
T.RESOURCES. An attacker prevents correct operation of the Java Card System through consumption of some resources of the card: RAM or NVRAM.	No contradiction.
T.DELETION. The attacker deletes an applet or a package already in use on the card, or uses the deletion functions to pave the way for further attacks (putting the TOE in an insecure state).	(PAP code) T.INTEG_SEL_ACT_PARAM
T.INSTALL. The attacker fraudulently installs post-issuance of an applet on the card. This concerns either the installation of an unverified applet or an attempt to induce a malfunction in the TOE through the installation process.	T.INTEG_SEL_ACT_PARAM
T.OBJ-DELETION. The attacker keeps a reference to a garbage collected object in order to force the TOE to execute an unavailable method, to make it to crash, or to gain access to a memory containing data that is now being used by another application.	All T.DISCLOSURE All T.INTEG T.TEMPORARY_DATA
Platform-ST / (U)SIM part	Composite-ST
T.UNAUTHORIZED_ACCESS_TO_SERVICE. An attacker may gain direct access to an optional platform service without authorization by bypassing access control to service activation.	No contradiction.

Table 1: Compatibility of threats

	Reference	D1270292	Release	1.01p <small>(Printed copy not controlled: verify the version before using)</small>
	Classification level	Public	Pages	133

3.2 Compatibility of OSP

Platform-ST / (U)SIM Basic PP part	Composite-ST
<p>OSP.SECURE-APPS-CERTIFICATION.</p> <p>Secure applications must be certified according to the Common Criteria at an EAL equal to the one of the current Protection Profile. The composition of these applications with the current PP must follow the rules defined in the document [CPESC]. These applications are associated to a digital signature which will be checked by a VA during the loading into the TOE.</p> <p>See [Secure APP] for more details on the evaluation/validation process.</p>	<p>No contradiction.</p> <p>Mobile Paypass 1.0 application is Secure APP.</p>
<p>OSP.BASIC-APPS-VALIDATION.</p> <p>Standard applications shall be associated to a digital signature which will be checked by a VA during the loading into the TOE. In addition to the rules stated by the Java Card specification, the validation process must enforce that standard applications:</p> <ul style="list-style-type: none"> • must follow the extra-rules stated in the user manual of the considered (U)SIM Java Card Platform, • cannot be libraries, • must not use RMI, • must not use proprietary libraries which are not certified (except system libraries), • access control to certified proprietary libraries is controlled by the secure application which has defined the library, • must be associated to an identifier and this identifier has to be used in parameter of the function calls. <p>See [Standard APP] for more details on the validation process.</p>	<p>No contradiction.</p> <p>PPSE, Payez Mobile and Payment Bridge applications are Standard APP.</p>
<p>OSP.SHARE-CONTROL.</p> <p>The Shareable interface functionality should be strictly controlled for all applications to prevent transitive data flows between applets (i.e., no resharing of a shareable object with a third applet) and thus prevent access to unauthorized data.</p>	<p>No contradiction.</p>
<p>OSP.AID-MANAGEMENT.</p> <p>When loading an application that uses shareable object interface, to make its services available to other applications, the VA or the MNO shall verify that the AID of the application being loaded does not impersonate the AID known by another application on the card for the use of shareable services.</p>	<p>No contradiction.</p> <p>Mobile Paypass 1.0 application is Secure APP.</p> <p>PPSE, Payez Mobile and Payment Bridge applications are Standard APP.</p>
<p>OSP.OTA-LOADING.</p> <p>Application code, validated or certified depending on the application, is loaded "Over The Air" (OTA) onto (U)SIM Platform using OTA servers of the mobile operator. If needed, the Card issuer can pre-authorize content loading operation through delegated management privilege to individual on-card representative of APs. In that case the application code is loaded in the APSD. Once loaded, the application is personalized using the appropriate SD keys.</p>	<p>No contradiction.</p> <p>Mobile Paypass 1.0 application is Secure APP.</p> <p>PPSE, Payez Mobile and Payment Bridge applications are Standard APP.</p>

	Reference D1270292	Release 1.01p <small>(Printed copy not controlled: verify the version before using)</small>
	Classification level Public	Pages 133

OSP.OTA-SERVERS. A security policy shall be employed by the mobile operator to ensure the security of the applications stored on its servers.	No contradiction. Mobile Paypass 1.0 application is Secure APP. PPSE, Payez Mobile and Payment Bridge applications are Standard APP.
OSP.APSD-KEYS. The APSD keys personalization can rely either on the key escrow if the APSD has been created before the usage phase of the (U)SIM card or on the CA if the APSD has been created during the usage phase.	No contradiction.
OSP.OPERATOR-KEYS. The security of the mobile operator keys (ISD keys) must be ensured by a well defined security policy that covers generation, storage, distribution, destruction and recovery. This policy is enforced by the mobile operator in collaboration with the personalizer.	No contradiction.
OSP.KEY-GENERATION. The personalizer must enforce a policy ensuring that generated keys cannot be accessed in plaintext.	No contradiction.
OSP.CASD-KEYS. The security domain keys of the CA must be securely generated and stored in the (U)SIM card during the personalization process. These keys are not modifiable after card issuance.	No contradiction.
OSP.VASD-KEYS. The security domain keys of the VA must be securely generated and stored in the (U)SIM card during the personalization process.	No contradiction. Mobile Paypass 1.0 application is Secure APP.
OSP.KEY-CHANGE. The AP shall change its initial security domain keys (APSD) before any operation on its Security Domain.	No contradiction.
OSP.SECURITY-DOMAINS. Security domains can be dynamically created, deleted and blocked during usage phase in post-issuance mode.	No contradiction.
OSP.QUOTAS. Security domains are subject to quotas of memory at creation.	No contradiction.
OSP.PRODUCTION. Production and personalization environment has to be secured as the TOE delivery occurs after Phase 6.	No contradiction.
OSP.PERSONALIZER. The personalizer under an Operator's Contract is in charge of the TOE personalization process before card issuance. He ensures the security of the keys he loads on the (U)SIM cards: <ul style="list-style-type: none"> Mobile operator keys including OTA keys (telecom keys either generated by the personalizer or by the mobile operator) and delegated management token keys 	No contradiction.

	Reference D1270292	Release 1.01p <small>(Printed copy not controlled: verify the version before using)</small>
	Classification level Public	Pages 133

<ul style="list-style-type: none"> • Issuer Security Domain keys (ISD keys or Card issuer keys), • Application Provider Security Domains keys (APSD keys). • Controlling Authority Security Domain keys (CASD keys) • Verification Authority Security Domain keys (VASD keys) 	
OSP.KEY-ESCROW. The key escrow is a trusted actor in charge of the secure storage of the initial AP keys generated by the TOE personalizer during initial personalization. He ensures the security of the keys.	
Platform-ST / JCS Open PP part	Composite-ST
OSP.VERIFICATION. This policy shall ensure the consistency between the export files used in the verification and those used for installing the verified file. The policy must also ensure that no modification of the file is performed in between its verification and the signing by the verification authority.	No contradiction. Mobile Paypass 1.0 application is Secure APP. PPSE, Payez Mobile and Payment Bridge applications are Standard APP. ALC comp.
Platform-ST / (U)SIM part	Composite-ST
OSP.Secure_API. The TOE must contribute to ensure that application can optimize control on its sensitive operations using a dedicated API provided by TOE. TOE will provide services for secure array management and to detect loss of data integrity and inconsistent execution flow and react against tearing or fault induction.	No contradiction. The Secure APIs are used by composite TOE.
OSP.RND. This policy shall ensure the entropy of the random numbers provided by the TOE to applet using [JCAPI] is sufficient. Thus attacker is not able to predict or obtain information on generated numbers.	No contradiction.
OSP.JCAPI-Services. This policy shall ensure that hashing and checksum security services defined in [JCAPI] provided by the TOE to applet is secure. Thus attacker is not able to predict or obtain information on manipulated data.	No contradiction.
OSP.TRUSTED-APPS-DEVELOPER. There are application developers (as Gemalto) considered as trusted by platform issuer and application providers. The confidence in these actors has been obtained by audit of development process and development environment performed by ITSEF during private scheme evaluation or Common Criteria composite evaluation process.	No contradiction. ALC comp.
OSP.TRUSTED-APPS-PRE-ISSUANCE-LOADING. For Pre-Issuance loading of trusted* applications, the audited process during Platform evaluation must be used.	No contradiction. ALC comp.
OSP.SERVICE_AUDIT. The MNO and activation administrator (usually Gemalto) can audit	No contradiction.

	Reference D1270292	Release 1.01p <small>(Printed copy not controlled: verify the version before using)</small>
	Classification level Public	Pages 133

optional platform service activation using remote service audit.	
OSP.ACTIVATION-KEY-ESCROW. The key escrow is a trusted actor in charge of the secure storage of the activation keys generated and stored outside of TOE and import in TOE by the TOE personalizer during initial personalization. He ensures the security of the keys for remote service activation.	No contradiction.
OSP.EMVUtil_API. The TOE must contribute to ensure that Banking application can optimize control on its sensitive operations using a dedicated API providing management of secure container and counter by TOE.	No contradiction. The Secure APIs are used by composite TOE.

Table 2: Compatibility of OSP

	Reference	D1270292	Release	1.01p <small>(Printed copy not controlled: verify the version before using)</small>
	Classification level	Public	Pages	133

3.3 Compatibility of assumptions

Platform-ST / (U)SIM Basic part	IrPA	CfPA	SgPA	Composite-ST
<p>A.MOBILE-OPERATOR.</p> <p>The mobile operator is a trusted actor responsible for the mobile network and the associated OTA servers. The mobile operator as Card issuer cannot get access or change the application data which belongs to the AP.</p>		X		AGD comp.
<p>A.OTA-ADMIN.</p> <p>Administrators of the mobile operator OTA servers are trusted people. They are trained to use and administrate securely those servers. They have the means and the equipments to perform their tasks. They are aware of the sensitivity of the assets they managed and the responsibilities associated to the administration of OTA servers.</p>		X		AGD comp.
<p>A.APPS-PROVIDER.</p> <p>The AP is a trusted actor that provides standard or secure applications. He is responsible for his security domain keys (APSD keys).</p>		X		AGD comp.
<p>A.VERIFICATION-AUTHORITY.</p> <p>The VA is a trusted actor who is able to guarantee and check the digital signature attached to a standard or secure application.</p>		X		AGD comp.
<p>A.CONTROLLING-AUTHORITY</p> <p>The CA is a trusted actor responsible for securing the APSD keys creation and personalization. He is responsible for his security domain keys (CASD keys).</p>		X		AGD comp.
Platform-ST / JCS Open part	IrPA	CfPA	SgPA	Composite-ST
<p>A.APPLET.</p> <p>Applets loaded post-issuance do not contain native methods. The Java Card specification explicitly "does not include support for native methods" ([JCVM222], §3.3) outside the API.</p>		X		AGD comp.
<p>A.VERIFICATION.</p> <p>All the bytecodes are verified at least once, before the loading, before the installation or before the execution, depending on the card capabilities, in order to ensure that each bytecode is valid at execution time.</p>		X		AGD comp.
Platform-ST / Addition part	IrPA	CfPA	SgPA	Composite-ST
None				

Table 3: Compatibility of assumptions

	Reference	D1270292	Release	1.01p <small>(Printed copy not controlled: verify the version before using)</small>
	Classification level	Public	Pages	133

3.4 Compatibility of TOE security objectives

Platform-ST / (U)SIM Basic PP part	Composite-ST (O, not used, irrelevant)
<p>O.CARD-MANAGEMENT. The TOE shall provide card management functionalities (loading, installation, extradition, deletion of applications and GP registry updates) in charge of the life cycle of the whole (U)SIM card and installed applications (applets).</p> <p>The card manager, the application with specific rights responsible for the administration of the smart card, shall control the access to card management functions. It shall also implement the card issuer's policy on card management.</p>	No contradiction
<p>O.DOMAIN-RIGHTS. The Card issuer shall not get access or change personalized AP security domain keys which belong to the AP. Modification of a security domain keyset is restricted to the AP who owns the security domain.</p>	No contradiction
<p>O.APPLI-AUTH. The card manager shall enforce the application security policies established by the card issuer by requiring application authentication during application loading on the card.</p>	O.GUIS_AUTH
<p>O.COMM-AUTH. The TOE shall authenticate the origin of the card management requests that the card receives, and authenticate itself to the remote actor.</p>	O.GUIS_AUTH O.MNO_AUTH
<p>O.COMM-INTEGRITY. The TOE shall verify the integrity of the card management requests that the card receives.</p>	O.DATA_INTEGRITY
<p>O.COMM-CONFIDENTIALITY The TOE shall be able to process card management requests containing encrypted data.</p>	O.DATA_DISCLOSURE
<p>O.SCP-SUPPORT. The TOE OS shall support the following functionalities:</p> <ul style="list-style-type: none"> (1) It does not allow the TSFs to be bypassed or altered and does not allow access to other low-level functions than those made available by the packages of the API. That includes the protection of its private data and code (against disclosure or modification) from the Java Card System. (2) It provides secure low-level cryptographic processing to the Java Card System, GlobalPlatform. (3) It supports the needs for any update to a single persistent object or class field to be atomic, and possibly a low-level transaction mechanism. (4) It allows the Java Card System to store data in "persistent technology memory" or in volatile memory, depending on its needs (for instance, transient objects must not be stored in 	All O

	Reference D1270292	Release 1.01p <small>(Printed copy not controlled: verify the version before using)</small>
	Classification level Public	Pages 133

non-volatile memory). The memory model is structured and allows for low-level control accesses (segmentation fault detection).	
Platform-ST / JCS Open PP part	Composite-ST
O.SID. The TOE shall uniquely identify every subject (applet, or package) before granting it access to any service.	No contradiction
O.FIREWALL. The TOE shall ensure controlled sharing of data containers owned by applets of different packages or the JCRE and between applets and the TSFs.	No contradiction
O.GLOBAL-ARRAYS-CONFID. The TOE shall ensure that the APDU buffer that is shared by all applications is always cleaned upon applet selection. The TOE shall ensure that the global byte array used for the invocation of the install method of the selected applet is always cleaned after the return from the install method.	No contradiction
O.GLOBAL-ARRAYS-INTEG. The TOE shall ensure that only the currently selected application may have a write access to the APDU buffer and the global byte array used for the invocation of the install method of the selected applet.	No contradiction
O.NATIVE. The only means that the Java Card VM shall provide for an application to execute native code is the invocation of a method of the Java Card API, or any additional API.	No contradiction
O.OPERATE. The TOE must ensure continued correct operation of its security functions.	No contradiction
O.REALLOCATION. The TOE shall ensure that the re-allocation of a memory block for the runtime areas of the Java Card VM does not disclose any information that was previously stored in that block.	No contradiction
O.RESSOURCES. The TOE shall control the availability of resources for the applications.	No contradiction
O.ALARM. The TOE shall provide appropriate feedback information upon detection of a potential security violation.	No contradiction
O.CIPHER. The TOE shall provide a means to cipher sensitive data for applications in a secure way. In particular, the TOE must support cryptographic algorithms consistent with cryptographic usage policies and standards.	No contradiction
O.KEY-MNGT.	No contradiction

	Reference D1270292	Release 1.01p <small>(Printed copy not controlled: verify the version before using)</small>
	Classification level Public	Pages 133

<p>The TOE shall provide a means to securely manage cryptographic keys. This concerns the correct generation, distribution, access and destruction of cryptographic keys.</p>	
<p>O.PIN-MNGT. The TOE shall provide a means to securely manage PIN objects.</p>	No contradiction
<p>O.REMOTE. The TOE shall provide restricted remote access from the CAD to the services implemented by the applets on the card. This particularly concerns the Java Card RMI services introduced in version 2.2.x of the Java Card platform.</p>	No contradiction
<p>O.TRANSACTION. The TOE must provide a means to execute a set of operations atomically.</p>	No contradiction
<p>O.OBJ-DELETION. The TOE shall ensure the object deletion shall not break references to objects.</p>	No contradiction
<p>O.DELETION. The TOE shall ensure that both applet and package deletion perform as expected.</p>	No contradiction
<p>O.LOAD. The TOE shall ensure that the loading of a package into the card is safe.</p>	No contradiction
<p>O.INSTALL. The TOE shall ensure that the installation of an applet performs as expected.</p>	No contradiction
<p>O.SCP.RECOVERY. If there is a loss of power, or if the smart card is withdrawn from the CAD while an operation is in progress, the SCP must allow the TOE to eventually complete the interrupted operation successfully, or recover to a consistent and secure state.</p>	No contradiction
<p>O.SCP.IC. The SCP shall provide all IC security features against physical attacks.</p>	No contradiction
Platform-ST / (U)SIM part	
Composite-ST	
<p>O.Secure_API. The TOE shall provide to application a secure_API means to optimize control on sensitive operations performed by application. TOE shall provide services for secure array management and to detect loss of data integrity and inconsistent execution flow and react against tearing or fault induction.</p>	No contradiction
<p>O.RNG. The TOE must contribute to ensure that random numbers shall not be predictable and shall have sufficient entropy.</p>	No contradiction
<p>O.JCAPI-Services.</p>	No contradiction

	Reference D1270292	Release 1.01p <small>(Printed copy not controlled: verify the version before using)</small>
	Classification level Public	Pages 133

<p>The TOE must contribute to ensure that data manipulated during SHA and CRC services as defined in [JCAPI] shall not be observed.</p>	
<p>O.REMOTE_SERVICE_AUDIT. The TOE shall perform remote service audit only when optional platform service audit is authorized and only by an authorized actor. Limited to MNO or GemActivate Administrator (usually Gemalto).</p>	No contradiction
<p>O.REMOTE_SERVICE_ACTIVATION. The TOE shall perform remote optional platform service activation only when service activation is authorized and only by an authorized actor. Limited to Gemactivate Administrator (usually Gemalto) under control of MNO.</p>	No contradiction
<p>O.EMVUtil_API. The TOE shall provide to banking application a secure_API to optimize control on sensitive object performed by application. TOE shall provide services for secure container and counter management and to detect loss of data integrity.</p>	No contradiction

Table 4: Compatibility of TOE security objectives

	Reference	D1270292	Release	1.01p <small>(Printed copy not controlled: verify the version before using)</small>
	Classification level	Public	Pages	133

3.5 Compatibility of security objectives for the environment

Platform-ST / (U)SIM Basic PP part	Composite-ST
<p>OE.MOBILE-OPERATOR.</p> <p>The mobile operator shall be a trusted actor responsible for the mobile network and the associated OTA servers.</p>	No contradiction
<p>OE.OTA-ADMIN.</p> <p>Administrators of the mobile operator OTA servers shall be trusted people. They shall be trained to use and administrate those servers. They have the means and the equipments to perform their tasks.</p> <p>They must be aware of the sensitivity of the assets they manage and the responsibilities associated to the administration of OTA servers.</p>	No contradiction
<p>OE.APPS-PROVIDER.</p> <p>The AP shall be a trusted actor that provides standard or secure application. He must be responsible of his security domain keys.</p>	No contradiction
<p>OE.VERIFICATION-AUTHORITY.</p> <p>The VA should be a trusted actor who is able to guarantee and check the digital signature attached to an application.</p>	No contradiction
<p>OE.CONTROLLING-AUTHORITY.</p> <p>The CA shall be a trusted actor responsible for securing the APSD keys creation and personalisation. He must be responsible for his security domain keys (CASD keys).</p>	No contradiction
<p>OE.SECURE-APPS-CERTIFICATION.</p> <p>Secure applications must be evaluated and certified at a security level higher or equal than the one of the current Protection Profile.</p>	No contradiction
<p>OE.BASIC-APPS-VALIDATION.</p> <p>Standard applications must be analysed during the validation process in order to ensure that the rules for correct usage of the TOE are still enforced.</p>	No contradiction
<p>OE.SHARE-CONTROL.</p> <p>All applications (standard and secure applications) must have means to identify the applications with whom they share data using the Shareable Interface.</p>	No contradiction
<p>OE.AID-MANAGEMENT.</p> <p>The VA or the MNO shall verify that the AID of the application being loaded does not impersonate the AID known by another application on the card for the use of shareable services.</p>	No contradiction
<p>OE.OTA-LOADING.</p> <p>Application code, validated or certified depending on the application, is loaded "Over The Air" (OTA) onto (U)SIM Platform using OTA servers. This process should protect the confidentiality and the integrity of the loaded application code.</p>	No contradiction
OE.OTA-SERVERS.	

	Reference D1270292	Release 1.01p <small>(Printed copy not controlled: verify the version before using)</small>
	Classification level Public	Pages 133

<p>The mobile operator must enforce a policy to ensure the security of the applications stored on its servers.</p>	
<p>OE.AP-KEYS. The SD keys personalizer, the AP and the key escrow must enforce a security policy on SD keys in order to secure their transmission.</p>	No contradiction
<p>OE.OPERATOR-KEYS. The security of the mobile operator keys must be ensured in the environment of the TOE.</p>	No contradiction
<p>OE.KEY-GENERATION. The security of the mobile operator keys must be ensured in the environment of the TOE.</p>	No contradiction
<p>OE.CA-KEYS. The security domain keys of the CA must be securely generated prior storage in the (U)SIM card.</p>	No contradiction
<p>OE.VA-KEYS. The security domain keys of the VA must be securely generated prior storage in the (U)SIM card.</p>	No contradiction
<p>OE.KEY-CHANGE. The AP must change its security domain initial keys before any operation on it.</p>	No contradiction
<p>OE.SECURITY-DOMAINS. Security domains can be dynamically created, deleted and blocked during usage phase in post-issuance mode.</p>	No contradiction
<p>OE.QUOTAS. Security domains are subject to quotas of memory at creation.</p>	No contradiction
<p>OE.PRODUCTION. Production and personalization environment if the TOE delivery occurs before Phase 6 of the TOE life cycle must be trusted and secure.</p>	No contradiction
<p>OE.PERSONALIZER. The personalizer shall be a trusted actor in charge of the personalization process. He must ensure the security of the keys it manages and loads into the card:</p> <ul style="list-style-type: none"> • Mobile operator keys including OTA keys (telecom keys either generated by the personalizer or by the mobile operator), • Issuer Security Domain keys (ISD keys), • Application Provider Security Domain keys (APSD keys). • Controlling Authority Security Domain keys (CASD keys) 	No contradiction
<p>OE.KEY-ESCROW. The key escrow shall be a trusted actor in charge of the secure storage of the AP initial keys generated by the personalizer.</p>	No contradiction
Platform-ST / JCS Open PP part	Composite-ST

	Reference D1270292	Release 1.01p <small>(Printed copy not controlled: verify the version before using)</small>
	Classification level Public	Pages 133

OE.APPLET. No applet loaded post-issuance shall contain native methods.	No contradiction
OE.VERIFICATION. All the bytecodes shall be verified at least once, before the loading, before the installation or before the execution, depending on the card capabilities, in order to ensure that each bytecode is valid at execution time.	No contradiction
Platform-ST / (U)SIM part	Composite-ST
OE.TRUSTED-APPS-DEVELOPER. The trusted application developer shall be a trusted actor that provides basic or secure application where correct usage of the TOE has been verified applying a secure development process in secure development environment.	No contradiction
OE.TRUSTED-APPS-PRE-ISSUANCE-LOADING. The trusted pre-issuance loading on the platform must be done only using verified applet applying an audited process in a secure environment.	No contradiction
OE.ACTIVATION-KEY-ESCROW. The key escrow is a trusted actor must ensure the security of the keys used for remote service activation during generation, storage, importation in TOE and usage.	No contradiction

Table 5: Compatibility of security objectives for the environment

	Reference	D1270292	Release	1.01p <small>(Printed copy not controlled: verify the version before using)</small>
	Classification level	Public	Pages	133

3.6 Compatibility of security functional requirements

Platform-ST / (U)SIM Basic part	RP_SFR	IP_SFR	Composite-ST
FCS_COP.1/DAP	X		
FDP_ITC.2/CCM	X		
FDP_ROL.1/CCM	X		
FDP_UIT.1/CCM	X		
FPT_FLS.1/CCM	X		
FDP_ACC.1/SD	X		
FDP_ACF.1/SD	X		
FMT_MSA.1/SD	X		
FMT_MSA.3/SD	X		
FMT_SMF.1/SD	X		
FMT_SMR.1/SD	X		
FCO_NRO.2/SC	X		
FDP_IFC.2/SC	X		
FDP_IFF.1/SC	X		
FIA_UID.1/SC	X		
FIA_UAU.1/SC	X		
FIA_UAU.4/SC	X		
FMT_MSA.1/SC	X		
FMT_MSA.3/SC	X		
FMT_SMF.1/SC	X		
FTP_ITC.1/SC	X		
Platform-ST / JCS Open part	RP_SFR	IP_SFR	Composite-ST
FDP_ACC.2/FIREWALL	X		
FDP_ACF.1/FIREWALL	X		
FDP_IFC.1/JCVM	X		
FDP_IFF.1/JCVM	X		
FDP_RIP.1/OBJECTS	X		
FMT_MSA.1/JCRE	X		
FMT_MSA.1/JCVM	X		
FMT_MSA.2/FIREWALL_JCVM	X		
FMT_MSA.3/FIREWALL	X		
FMT_MSA.3/JCVM	X		
FMT_SMF.1	X		
FMT_SMR.1	X		

	Reference	D1270292	Release	1.01p <small>(Printed copy not controlled: verify the version before using)</small>
	Classification level	Public	Pages	133

FCS_CKM.1/DES	X		
FCS_CKM.1/AES		X	Not used
FCS_CKM.1/RSA	X		
FCS_CKM.2/DES	X		
FCS_CKM.2/AES		X	Not used
FCS_CKM.2/RSA	X		
FCS_CKM.3/DES	X		
FCS_CKM.3/AES		X	Not used
FCS_CKM.3/RSA	X		
FCS_CKM.4	X		
FCS_COP.1/DES_CIPHER	X		
FCS_COP.1/DES_MAC_COMP	X		
FCS_COP.1/AES_CIPHER		X	Not used
FCS_COP.1/AES_MAC_COMP		X	Not used
FCS_COP.1/RSA_SIGN	X		
FCS_COP.1/RSA_CIPHER	X		
FCS_COP.1/HMAC			
FDP_RIP.1/ABORT	X		
FDP_RIP.1/APDU	X		
FDP_RIP.1/bArray	X		
FDP_RIP.1/KEYS	X		
FDP_RIP.1/TRANSIENT	X		
FDP_ROL.1/FIREWALL	X		
FAU_ARP.1	X		
FDP_SDI.2	X		
FPR_UNO.1	X		
FPT_FLS.1/JCS	X		
FPT_TDC.1	X		
FIA_ATD.1/AID	X		
FIA_UID.2/AID	X		
FIA_USB.1/AID	X		
FMT_MTD.1/JCRE	X		
FMT_MTD.3/JCRE	X		
FDP_ITC.2/Installer	X		
FMT_SMR.1/Installer	X		
FPT_FLS.1/Installer	X		

	Reference	D1270292	Release	1.01p <small>(Printed copy not controlled: verify the version before using)</small>
	Classification level	Public	Pages	133

FPT_RCV.3/Installer	X		
FDP_ACC.2/ADEL	X		
FDP_ACF.1/ADEL	X		
FDP_RIP.1/ADEL	X		
FMT_MSA.1/ADEL	X		
FMT_MSA.3/ADEL	X		
FMT_SMF.1/ADEL	X		
FMT_SMR.1/ADEL	X		
FPT_FLS.1/ADEL	X		
FDP_ACC.2/JCRMI	X		
FDP_ACF.1/JCRMI	X		
FDP_IFC.1/JCRMI	X		
FDP_IFF.1/JCRMI	X		
FMT_MSA.1/EXPORT	X		
FMT_MSA.1/REM_REFS	X		
FMT_MSA.3/JCRMI		X	Not used
FMT_REV.1/JCRMI		X	Not used
FMT_SMF.1/JCRMI		X	Not used
FMT_SMR.1/JCRMI		X	Not used
FDP_RIP.1/ODEL	X		
FPT_FLS.1/ODEL	X		
FCO_NRO.2/CM	X		
FDP_IFC.2/CM	X		
FDP_IFF.1/CM	X		
FDP_UIT.1/CM	X		
FIA_UID.1/CM	X		
FMT_MSA.1/CM	X		
FMT_MSA.3/CM	X		
FMT_SMF.1/CM	X		
FMT_SMR.1/CM	X		
FTP_ITC.1/CM	X		
FPT_RCV.3/OS	X		
FPT_RCV.4/OS	X		
Platform-ST / Addition part	RP_SFR	IP_SFR	Composite-ST
FCS_COP.1/SHA2	X		
FCS_COP.1/CRC	X		

	Reference	D1270292	Release	1.01p <small>(Printed copy not controlled: verify the version before using)</small>
	Classification level	Public	Pages	133

FCS_RND.1	X		FIA_SOS.2
FPT_FLS.1/SecureAPI	X		
FPT_ITT.1/SecureAPI	X		
FPR_UNO.1/SecureAPI	X		
FMT_SMR.1/GemActivate		X	Not used
FMT_SMF.1/GemActivate		X	Not used
FMT_MOF.1/GemActivate		X	Not used
FMT_MSA.1/GemActivate		X	Not used
FMT_MTD.1/GemActivate		X	Not used
FPT_ITT.1/EMVUtilAPI	X		
FDP_SDI.1/EMVUtilAPI	X		

Table 6: Compatibility of security functional requirements

3.7 Compatibility of security functional requirements for the environment

Not applicable.

3.8 Compatibility of assurance requirements

The EAL4+ chosen for the composite-ST evaluation does not exceed the EAL4+ applied to the evaluation of the platform-ST.

	Reference D1270292	Release 1.01p <small>(Printed copy not controlled: verify the version before using)</small>
	Classification level Public	Pages 133

4 Security Problem Definition

4.1 Assets

This section identifies the assets of the PAP, protected by a combination of (U)SIM platform and PAP itself. Note that the PAP code is an asset of the (U)SIM platform, protected in integrity by means of JavaCard System access control.

In the following, the description of each asset states the type of protection required.

4.1.1 User data

User data are created by and for the user. These data do not affect the operation of the TSF. The following assets are user data.

POS Transaction Data

All data transmitted to the PAP from the POS terminal. This includes: Country Code, Terminal Verification Result, etc.

Protection: integrity.

Issuing Bank Transaction Data

All transaction data transmitted to the PAP by the Issuing Bank including Issuing Bank authentication data, ARPC, CDOL2, etc.

Protection: integrity.

Issuing Bank Scripts

All the scripts transmitted by the Issuing Bank to update PAP Transaction Parameters and PAP internal states (Application Block/Unblock, Counter Reset, Change/Unblock the Personal Code, etc)

Protection: integrity.

MNO Data

All data transmitted to the TOE by the MNO including the MNO authentication data.

Protection: integrity.

PAP Log File

PAP Log File and its associated format under EMV rules. This asset contains the log data of the last transactions performed by the PAP.

Protection: integrity

Customer Account Information

All customer bank account data including the PAN, the PAN Sequence Number, expiration date.

Protection: integrity.

PAP keys

The cryptographic keys owned by the payment application instances.

Protection: integrity and confidentiality

Application Note:

	Reference D1270292	Release 1.01p <small>(Printed copy not controlled: verify the version before using)</small>
	Classification level Public	Pages 133

This asset includes secret keys, private keys and random numbers used for secret key generation.

PAP Transaction Parameters

Any data used for internal card risk management, including last on-line ATC, PAP AID, PDOL data, Currency code, Personal Code Entry Floor Limit, Personal Code indicators, CDOL1, CVM, PK certificates.

Protection: integrity.

PAP Selection and Activation parameters

The parameters allowing the POS to perform the selection and activation of the embedded PAP.

Protection: integrity.

Application Note:

For instance the AID, the longAID, the AFL, contactless life cycle state, etc.

4.1.2 TSF data

TSF data are data might affect the operation of the TOE.

4.1.2.1 TRANSACTION MANAGEMENT DATA

Reference Personal Code

The stored value of the Personal Code which allows the authentication of the customer to the PAP. This includes related parameters for entry checking (POS currency, Personal Code Entry Limit).

Protection: integrity and confidentiality.

PAP Counters

This asset covers two types of counters:

- risk analysis counters which is data used to count sensitive operations, for instance, the number of transactions processed by the PAP (ATC),

- secure counters such as the number of failed attempts to present the Personal Code (Personal Code Try Counter).

Protection: integrity

PAP State Machine

The PAP State Machine stores information about the PAP application internal states during its usage phase.

Protection: integrity.

4.1.2.2 TEMPORARY TRANSACTION DATA

PAP Transaction Data

All data used by the PAP when performing payment transactions, including Card Challenge, Dynamic Authentication related data, Session Keys, Card Verification Results, Cryptograms (AAC, TC and ARQC).

Protection: integrity

	Reference	D1270292	Release	1.01p <small>(Printed copy not controlled: verify the version before using)</small>
	Classification level	Public	Pages	133

4.2 Users / Subjects

4.2.1 USERS

Users are entities (human or IT) outside the TOE that interact with the TOE.

U.CUSTOMER

The customer interacts with the TOE in its usage phase. The customer is able to perform a transaction using the PAP embedded in the (U)SIM card of his mobile handset.

U.ISSUING_BANK

The Issuing Bank is the PAP provider. The Issuing Bank is responsible of payment transactions authorisation and PAP administration (i.e. loading of PAP code, data and keys belonging to a specific customer).

U.MERCHANT_POS

The POS terminal used by the merchant. It initiates transactions with the PAP in the customer's mobile handset for payment of a good or a service.

U.MNO

The Mobile Network Operator is the (U)SIM Card Issuer. The MNO provides cards to the customers. The MNO is responsible for the secure management of all pre-issuance phases of the (U)SIM card life cycle status and for some post-issuance processes.

Application Note:

The MNO can provide privileges to Issuing Banks via the Delegated Management functionality. The MNO can also manage authorisation of applications permitted to reside on its (U)SIM cards.

U.APP

Any sensitive or non-sensitive application embedded in the (U)SIM card besides the PAP.

U.BANK_GUI

This is a graphical interface loaded into the mobile handset, that allows the customer to access to the functions associated to their CMP applications.

U.BANK_MNG_SW

This is the software that is in charge of establishing a secure channel with the (U)SIM to tunnel PAP management functions (loading, updating,...) and data.

U.MNO_MNG_SW

This is the software that is in charge of establishing a secure channel with the (U)SIM to tunnel MNO's management functions and data.

4.2.2 SUBJECTS

Subjects are active entities in the (U)SIM.

S.PAP

The PAP subject is the Payment Application Package.

	Reference D1270292	Release 1.01p <small>(Printed copy not controlled: verify the version before using)</small>
	Classification level Public	Pages 133

S.BANK_TSM

The Bank TSM allows the Issuing Bank to submit PAP management operations (installation, selection, activation, block, counter reset, etc).

S.MNO_ISD

The MNO Issuer Security Domain allows the MNO to verify the Issuing Bank management operations in a Delegated Management privilege mode (token verification).

4.3 Threats

A threat agent wishes to abuse the assets by physical or logical attacks or by any other type of attacks. Any user may act as a threat agent.

4.3.1 DISCLOSURE

Unauthorised disclosure of assets.

T.DISCLOSURE_KEYS

An attacker may perform attacks leading to unauthorised knowledge of the keys.

Assets threatened: PAP keys.

T.DISCLOSURE_REF_PC

An attacker may perform attacks leading to unauthorised knowledge of the Reference Personal Code.

Assets threatened: Reference Personal Code.

4.3.2 INTEGRITY

Unauthorised modification of assets.

T.INTEG_LOG_FILE

Unauthorised modification of stored log files: an attacker modifies the log of transactions in order to hide malicious operations.

Asset threatened: PAP Log File.

T.INTEG_KEYS

Unauthorised modification of stored keys: an attacker modifies the value of the keys in order to input a known key.

Assets threatened: PAP keys.

T.INTEG_ACCOUNT_INFO

Unauthorised modification of stored customer account information: for instance an attacker modifies the value of the PAN.

Assets threatened: Customer Account Information.

T.INTEG_REF_PC

Unauthorised modification of stored Reference Personal Code: an attacker modifies the value of the Reference Personal Code stored in the PAP, for instance, in order to enter a known one.

Assets threatened: Reference Personal Code.

	Reference D1270292	Release 1.01p <small>(Printed copy not controlled: verify the version before using)</small>
	Classification level Public	Pages 133

T.INTEG_TRANS_PARAM

Unauthorised modification of stored transactions parameters: an attacker modifies the value of transaction parameters which define the configuration of the PAP in order to bypass controls or a limitation enforced by the bank's risk management and let the PAP accepting counterfeited or replayed transactions.

Assets threatened: PAP Transaction Parameters, PAP State Machine.

T.INTEG_COUNT

Unauthorised modification of risk analysis counters or secure counters. Such as the Personal Code Try Counter stored in the TOE: an attacker modifies the value of the Personal Code Try Counter stored in the PAP in order to change the limitation of the number of failing Personal Code required and finally gets unauthorised permission to submit a payment transaction.

Assets threatened: PAP Counters.

T.TEMPORARY_DATA

Unauthorised modification of temporary transaction data: an attacker modifies the value of transaction data in order to authorise counterfeited or replayed transactions.

Assets threatened: PAP Transaction Data, POS Transaction Data, Issuing-Bank Scripts, MNO Data, Issuing Bank Transaction Data.

T.INTEG_SEL_ACT_PARAM

Unauthorised modification of stored selection and activation parameters: an attacker modifies the value of parameters allowing the POS to perform the selection and activation of the embedded PAP in order to select and activate a counterfeited PAP.

Assets threatened: PAP Selection and Activation Parameters.

4.3.3 FRAUDULENT PAYMENT

T.STEALING

An attacker identifies and steals the mobile handset of the legitimate customer and if necessary disables the OTA channel (activating of the airplane mode, for instance) in order to use it to submit payment transactions.

Assets threatened: All assets.

T.MERCHANT_ACCOMPLICE

An attacker deals with a merchant in order to split payment into small amount payments that do not require Personal Code entry.

Assets threatened: PAP Transaction Parameters.

T.MAN-IN-THE-MIDDLE

An attacker installs on his mobile handset an application or uses a NFC device that is capable of relaying communications from the POS terminal to a mobile handset including a genuine payment application via NFC bearer or OTA bearer. The attacker presents his mobile handset or his NFC device to the POS terminal for a payment transaction, the request for payment is relayed from the POS terminal, through one or more intermediate attackers fake devices (NFC devices), to the victims mobile handset, which may be at a considerable distance.

Assets threatened: PAP Transaction parameters, PAP Counters.

T.TRANSACTION_REPUDIATION

Performing payment transactions without the customer authentication. It can lead to the repudiation of those transactions by the customer.

	Reference D1270292	Release 1.01p <small>(Printed copy not controlled: verify the version before using)</small>
	Classification level Public	Pages 133

Assets threatened: PAP Log File and PAP Transaction Parameters.

T.TRANSACTION_COUNTERFEITING

Counterfeiting of payment transactions. This may take several forms depending on the type of the data available to the attacker:

- knowledge of all personalisation data to clone a payment application;
- knowledge of the MNOs master key or the Bank's TSM key to make a real fake payment application;
- exploiting cryptographic weaknesses to determine the keys.

Assets threatened: PAP keys, PAP Transaction Parameters, Customer Account Information, PAP Transaction Data.

T.TRANSACTION_REPLAY

Replay of a previous complete sequence of transaction operations.

Asset threatened: PAP Transaction data, POS Transaction data, Issuing Bank Transaction Data.

Application Note:

This attack may be done by exploiting cryptographic weaknesses to determine the random values used, for instance, in DDA computation and session key diversification in order to replay previous transactions and usurpate users' identities.

4.3.4 DENIAL-OF-SERVICE

T.CERTIF_CORRUPTION

Corruption of the transaction data (certificates) in order to deny participation to the transaction under the terms claimed by one party.

Assets threatened: PAP Transaction Parameters, PAP Transaction Data, POS Transaction Data.

T.APPLICATIONS_DOS

Exploiting OTA bearer or NFC bearer, an attacker initiates transactions of small amounts by simulating a POS terminal. He may also install fraudulently an application on the mobile handset (GUI) that initiates transactions with the (U)SIM card. This attack may cause denial of service on the payment applications.

Assets threatened: Issuing-Bank Scripts, MNO Data, Issuing Bank Transaction Data.

4.3.5 IDENTITY_USURPATION

T.MNO_USURPATION

An attacker is illegally granted the rights of the MNO to modify the transactions parameters in order to authorise fraudulent transactions.

Assets threatened: MNO Data.

T.ISSUING-BANK_USURPATION

An attacker is illegally granted rights of the Issuing Bank to make unauthorised PAP management operations.

Assets threatened: Issuing Bank Transaction Data.

T.CUSTOMER_USURPATION

An attacker is illegally granted the rights of the legitimate customer to submit unauthorised transactions on his/her behalf.

	Reference D1270292	Release 1.01p <small>(Printed copy not controlled: verify the version before using)</small>
	Classification level Public	Pages 133

Assets threatened: All assets.

Application Note: Those attacks could be made by exploiting cryptographic weaknesses to determine the keys or random values used in the authentication process in order to usurpate users' identities.

4.4 Organisational Security Policies

4.4.1 HANDSET

OSP.POLICY

The mobile handset implements a security policy and a control access policy to resources ((U)SIM, network, etc)

OSP.CUSTOMER_PC_CONFID

The mobile handset never conserves the customer's Personal Code in its memory.

OSP.GUIS_IDENTIFICATION

The handset implements an access control mechanism that identifies GUIs authorised to communicate with the PAP (Cardlets).

4.4.2 MANAGEMENT

OSP.CERTIFICATES_MNGT

The lifetime of the (EMV-CDA) authentication certificates with the payment terminal varies according to the type of the payment application (application lifetime), and the (U)SIM card (lifetime). These certificates are updated via OTA during the term of the contract signed with the customer. Updating EMV certificates makes compromised payment applications inoperative.

OSP.Contactless_life cycle_MNGT

Each PAP holds the "Contactless Life Cycle State", which takes values from: ACTIVATED, DEACTIVATED, NON-ACTIVATABLE.

In a *Payez Mobile* implementation, there shall be at maximum one payment application in "ACTIVATED" state. The *Payez Mobile* application handles this requirement deactivating the previous payment application when a new one requests is activated. When the *Payez Mobile* application receives a notification from the CRS API that a payment application has just been activated, it uses the GP mechanisms as defined in the amendment C [GP-5] to deactivate the previous active payment application.

OSP.TOE_USAGE

The customer never reveals their Personal Code so that an attacker is unable to grant the rights of the legitimate customer to submit unauthorised transactions on his/her behalf. The customer shall respect the security rules given by the Issuing Bank.

OSP.PISHING

The Bank shall forbid remote payments (e.g. internet transactions), Mail Order / Telephone Order (MOTO), cash advance, quasi-cash and ATM cash withdrawal) so that an attacker cannot forge a message for the legitimate customer by usurpating his bank's identity in order to obtain desired information from him (name, address, PAN, activation code).

	Reference D1270292	Release 1.01p <small>(Printed copy not controlled: verify the version before using)</small>
	Classification level Public	Pages 133

4.4.3 MERCHANT

OSP.MERCHANT_CONTROL

The Acquirer applies a specific security policy regarding the secure usage of the POS by the Merchant.

Application Note:

The Acquirer's role is:

- *acquires and processes clearing transaction files;*
- *forwards authorisation and clearing messages from the Merchant point of sale to the Issuing Bank through a Payment Scheme network;*
- *provides an accurate and reliable transaction flow transmission from the Merchant POS to the Issuing Bank;*
- *provides a POS terminal compliant with the Payment Scheme requirements and with the functionalities defined within the Payez Mobile specifications.*

4.4.4 BANK

OSP.BANKS_PRIVILEGES

The Issuing Bank has specific privileges. For instance:

- the ability to request the value of the ATC and Offline counters. That request should be done randomly or on response to an incident reported by the customer;
- the ability to reset offline counters through OTA bearer;
- the ability to perform complete personalisation of its dedicated payment application through OTA bearer.

4.5 Assumptions

A.MERCHANT_AUTH

Merchant contract subscription guarantees the authenticity of the Merchant.

	Reference	D1270292	Release	1.01p (Printed copy not controlled: verify the version before using)
	Classification level	Public	Pages	133

5 Security Objectives

5.1 Security Objectives for the TOE

5.1.1 TRANSACTION PROTECTION

O.TRANSACTION_UNIQUENESS

The TOE shall preserve the uniqueness of a transaction by limiting the probability of generating two identical copies of transactions certificates.

O.TRANSACTION_INTEGRITY

The TOE shall preserve the integrity of transactions and the integrity of all certified terms of the transactions.

O.TRANSACTION_BYPASS

The TOE shall prevent from bypassing a mandatory step of the transaction flow model as defined by the [PM-1] and [PM-2] specifications.

O.TRANSACTION_REPLAY

The TOE shall detect and reject replayed transactions.

5.1.2 AUTHENTICATION

O.USER_AUTH

The TOE shall provide customer authentication means for Personal Code change/unblock and for each payment transaction above the Personal Code Entry Limit.

Application Note:

No further customer authentication attempts shall be possible once the maximal number of attempts has been reached, until a special action is performed by a privileged user.

O.ISSUING_BANK_AUTH

The TOE shall authenticate the Issuing Bank before processing administration transactions.

O.MNO_AUTH

The TOE shall authenticate the MNO before granting him access to its services.

Handled by the (U)SIM platform (see O.COMM_AUTH in [PP USIM])

5.1.3 EXECUTION PROTECTION

The correct execution of the services provided by the PAP, applications resources control and applications isolation are handled by the (U)SIM platform on which the payment application package is embedded. They are satisfied by technical countermeasures implemented by the (U)SIM platform. [PP USIM]

O.AUTHORISATION_CONTROL

The consistency of payment transactions shall be checked according to *Payez Mobile* specifications [PM-1] and [PM-2] before granting the customer the authorisation to submit payment transactions.

	Reference D1270292	Release 1.01p <small>(Printed copy not controlled: verify the version before using)</small>
	Classification level Public	Pages 133

5.1.4 DATA PROTECTION

O.DATA_DISCLOSURE

The TOE shall avoid unauthorised disclosure of TSF data stored and manipulated by the TOE and that must be protected in confidentiality.

Application Note:

This security objective is partially handled by the (U)SIM platform regarding physical attacks and unobservability of secrets.

O.DATA_INTEGRITY

The TOE shall avoid unauthorised modification of user data and TSF data managed or manipulated by the TOE.

O.DATA_USERS

The TOE shall ensure that user data are only accessed by authorised users.

5.1.5 RISK MANAGEMENT

O.RISK_MNGT

The TOE security functions behavior is limited by maximum values of risk management counters (number of transactions without authorisation, the aggregated amount without authorisation) that trigger an online authorisation request. These mechanisms are valid regardless the amount of the payment transaction.

O.APP_BLOCK

The TOE shall grant an authorised user the privilege to block the PAP and its data in a way to prohibit a positive response to payment authorisation requests. This is remotely operated through OTA bearer.

O.SIM_UNLOCK

The TOE shall require unlocking the (U)SIM card (by means of the PIN code) for each payment transaction.

Application Note:

Handled by the (U)SIM platform (see O.COMM_AUTH in [PP USIM])

O.AUDIT

The TOE shall record transactions to support effective security management.

O.CHANNELS

The TOE shall provide the means to identify the origin of a communication request intended to be routed by a specific communication channel (e.g. SWP for communications between the (U)SIM and the NFC Controller).

O.AUDIT_ACCESS

The TOE shall grant the customer access to log files in order to check the history of payment transactions that he has made lately.

	Reference D1270292	Release 1.01p <small>(Printed copy not controlled: verify the version before using)</small>
	Classification level Public	Pages 133

5.1.6 GUI

O.GUIS_AUTH

The TOE ((U)SIM Platform and PAP) shall authenticate the GUIs authorised to communicate with the applications of (U)SIM card (Cardlets) before granting them access to its functionalities. The applications shall only accept communication from authenticated GUIs.

Application Note:

Handled by the (U)SIM platform (see O.APPLI_AUTH and O.COMM_AUTH in [PP USIM])

This security objective is handled by the (U)SIM platform..

5.2 Security objectives for the Operational Environment

5.2.1 HANDSET

OE.CUSTOMER_PC_CONFID

The mobile handset shall preserve the customer's Personal Code from disclosure during its transmission to the PAP in order to be compared with the Reference Personal Code. Thus, the mobile handset shall never keep the customer's Personal Code in its memory.

OE.GUI_INST_ALERT

The mobile handset shall provide mechanisms for determining the legitimacy of an installed GUI, alerting the customer on application installation attempts.

OE.TOE_USAGE

The Issuing Bank shall communicate to the customer the rules dealing with the use of the PAP. Especially it must inform the customer that he must not divulgate his Personal Code to anyone.

The customer shall enforce these rules.

OE.GUIS_IDENTIFICATION

The handset shall implement an access control mechanism that identifies GUIs authorised to communicate with the TOE (Cardlets).

OE.POLICY

The mobile handset shall implement a security policy and a control access policy to resources ((U)SIM, network,etc)

OE.NFC_PROTOCOL

The implementation of NFC protocol shall be compliant with ISO 14443. In particular, payment transactions shall be disabled beyond a given distance.

OE.TRANSACTION_DISPLAY

Related payment transaction information (amount, transaction status, etc) shall be systematically displayed on the screen of the customers mobile handset before or after the transaction.

OE.CHANNELS_SELECTION

The mobile handset shall provide the means to the customer to fix the communication channels that permit to communicate with the TOE (eg NFC, OTA, Bluetooth).

	Reference D1270292	Release 1.01p <small>(Printed copy not controlled: verify the version before using)</small>
	Classification level Public	Pages 133

OE.GUIS_TIMEOUT

The GUIs shall detect when Personal Code Timeout limit values and unsuccessful authentication attempts occur related to the Personal Code timeout session. When the defined number of unsuccessful authentication attempts has been surpassed, the GUI shall request the Personal Code again.

5.2.2 MERCHANT

OE.MERCHANT_CONTROL

In particular, a specific security policy shall be established by the Acquirer regarding the secure usage of the POS, by controlling the Merchants transactions flow in order to detect suspicious behavior.

Application Note:

For instance, by controlling Merchants accepting small payments amounts.

OE.MERCHANT_AUTH

The merchant shall subscribe for a contract that guarantees his authenticity.

OE.LATENCY_CONTROL

The POS terminal shall implement time-out mechanisms that disable NFC transactions with low latency.

OE.POS_APPROVAL

Payment terminals accepting *Payez Mobile* payment transactions shall be approved by a reference body.

OE.POS_APPLICATIONS

The contactless payment applications embedded in the POS terminal shall be protected in integrity and authenticity.

Application Note:

For instance, those applications are signed by a trusted third party and their signature is checked during installation process.

OE.POS_DEACTIVATION

Any POS terminal may be rendered inoperative remotely by the POS purchaser or the Acquirer.

5.2.3 MANAGEMENT

OE.CERTIFICATES_MNGT

The lifetime of the (EMV-CDA) authentication certificates with the payment terminal shall be variable according to the type of the payment application (transaction amount, application lifetime), and the (U)SIM card (lifetime). These certificates shall be updated via OTA during the term of the contract signed with the customer.

OE.Contactless_life cycle_MNGT

Upon a new activation request, *Payez Mobile* application is responsible for managing the deactivation of the current activated PAP. The *Payez Mobile* application shall guarantee that only one PAP is activated at any given time.

	Reference D1270292	Release 1.01p <small>(Printed copy not controlled: verify the version before using)</small>
	Classification level Public	Pages 133

5.2.4 BANK

OE.NO_VAD

Remote payments (e.g. internet transactions), Mail Order / Telephone Order (MOTO), cash advance, quasi-cash and ATM cash withdrawal) shall be forbidden by the banks for PAP payments. Only proximity purchase transactions shall be authorised.

OE.BANKS_PRIVILEGES

The Issuing Bank shall be granted specific privileges.

5.3 Security Objectives Rationale

5.3.1 Threats

5.3.1.1 DISCLOSURE

T.DISCLOSURE_KEYS This threat is covered by the security objective O.DATA_DISCLOSURE which guarantees the secrecy of the keys stored in the TOE.

The security objective O.ISSUING_BANK_AUTH ensures that nobody but the Issuing Bank can operate on PAP cryptographic keys stored in the TOE.

The security objective on the operational environment OE.CERTIFICATES_MNGT also contributes in covering this threat by guaranteeing that certificates are updated and thus prevent from reusing a disclosed key.

T.DISCLOSURE_REF_PC This threat is covered by the security objective O.DATA_DISCLOSURE which guarantees the secrecy of the Reference Personal Code stored in the TOE.

The security objectives O.ISSUING_BANK_AUTH and O.USER_AUTH ensures that nobody but the Issuing Bank or the Customer can operate on the Personal Code.

5.3.1.2 INTEGRITY

T.INTEG_LOG_FILE This threat is covered by the security objective O.DATA_INTEGRITY which prevents from unauthorised modification of log files stored in the TOE.

The security objectives O.GUIS_AUTH and O.ISSUING_BANK_AUTH contribute in covering this threat by ensuring that only authorised users can get access to log files.

T.INTEG_KEYS This threat is covered by the security objective O.DATA_INTEGRITY which prevents from unauthorised modification of keys stored in the TOE.

The security objectives O.USER_AUTH, O.GUIS_AUTH, O.MNO_AUTH and O.ISSUING_BANK_AUTH contribute in covering this threat by ensuring that only authorised users can get access to the TOE.

T.INTEG_ACCOUNT_INFO This threat is covered by the security objective O.DATA_INTEGRITY which prevents from unauthorised modification of the customer account information stored in the TOE.

The security objectives O.USER_AUTH, O.GUIS_AUTH and O.ISSUING_BANK_AUTH contribute in covering this threat by ensuring that only authorised users can get access to the TOE.

	Reference D1270292	Release 1.01p <small>(Printed copy not controlled: verify the version before using)</small>
	Classification level Public	Pages 133

T.INTEG_REF_PC This threat is covered by the security objective O.DATA_INTEGRITY which prevents from unauthorised modification of Reference Personal Code stored in the TOE.

The security objectives O.USER_AUTH, O.GUIS_AUTH and O.ISSUING_BANK_AUTH contribute in covering this threat by ensuring that only authorised users can get access to the TOE.

T.INTEG_TRANS_PARAM This threat is covered by the security objective O.DATA_INTEGRITY which prevents from unauthorised modification of transaction parameters stored in the TOE.

The security objective O.TRANSACTION_BYPASS covers this threat by preventing from bypassing a mandatory step of the transaction flow model as defined by the [PM-1]&[PM-2] specifications and though ensuring the integrity of transaction parameters.

The security objectives O.USER_AUTH, O.GUIS_AUTH and O.ISSUING_BANK_AUTH contribute in covering this threat by ensuring that only authorised users can get access to the TOE.

T.INTEG_COUNT This threat is covered by the security objective O.DATA_INTEGRITY which prevents from unauthorised modification of PAP counters stored in the TOE.

The security objective O.TRANSACTION_BYPASS covers this threat by preventing from bypassing a mandatory step of the transaction flow model as defined by the [PM-1]&[PM-2] specifications and though ensuring the integrity of PAP counters.

The security objectives O.USER_AUTH, O.GUIS_AUTH and O.ISSUING_BANK_AUTH contribute in covering this threat by ensuring that only authorised users can get access to the TOE.

T.TEMPORARY_DATA This threat is covered by the security objectives O.DATA_INTEGRITY and O.TRANSACTION_INTEGRITY which prevent from unauthorised modification of transactions and related temporary data.

The security objectives O.USER_AUTH, O.GUIS_AUTH and O.ISSUING_BANK_AUTH contribute in covering this threat by ensuring that only authorised users can get access to the TOE.

T.INTEG_SEL_ACT_PARAM This threat is covered by the security objective O.DATA_INTEGRITY which prevents from unauthorised modification of selection and activation parameters stored in the TOE.

The security objectives O.USER_AUTH, O.GUIS_AUTH and O.ISSUING_BANK_AUTH contribute in covering this threat by ensuring that only authorised users can get access to the TOE.

	Reference D1270292	Release 1.01p <small>(Printed copy not controlled: verify the version before using)</small>
	Classification level Public	Pages 133

5.3.1.3 FRAUDULENT PAYMENT

T.STEALING This threat is countered by:

- O.RISK_MNGT which diminishes payment temptations by limiting the number of transactions without authorisation.
- O.APP_BLOCK which provides the Issuing Bank means to block the PAP through OTA bearer on the user's demand.
- O.USER_AUTH which ensures that the customer is authenticated for each payment transaction above the Personal Code Entry Limit
- OE.TOE_USAGE which ensures that the Issuing Bank provides to the customer the rules to securely use his TOE.
- OE.CUSTOMER_PC_CONFID which guarantees that the mobile handset never keeps the customer's Personal Code in its memory.
- OE.CERTIFICATES_MNGT that contributes in covering this threat by avoiding the usage of a stolen authentication certificates by providing updates.

T.MERCHANT_ACCOMPLICE This threat is covered by the security objective O.SIM_UNLOCK which requires unlocking the (U)SIM card (by means of the PIN code) for each payment transaction.

The security objective O.APP_BLOCK provides the means to authorised users to block the PAP in order to prevent from such attacks.

The security objective on the environment OE.MERCHANT_AUTH ensure that merchant shall subscribe for a contract that guarantees his authenticity.

The security objectives for the environment OE.POS_DEACTIVATION, OE.POS_APPROVAL and OE.POS_APPLICATIONS ensure respectively that the POS may be rendered inoperative remotely by the POS purchaser or the Acquirer, that payment terminals accepting *Payez Mobile* payment transactions are approved by a reference body, and that the contactless payment applications embedded in the POS terminal is protected in integrity and authenticity.

T.MAN-IN-THE-MIDDLE This threat is covered by the following security objectives:

- O.CHANNELS that provides the means to identify the origin of a communication request intended to be routed by a specific communication channel which decrease the probability of realizing such attacks
- O.USER_AUTH contributes in covering this threat by ensuring that the customer is authenticated before performing a payment transaction
- O.AUDIT_ACCESS grants the customer access to log files in order to check the history of payment transactions so that he can check if no fraudulent transaction has been made
- O.AUDIT records transaction to support security management

	Reference D1270292	Release 1.01p <small>(Printed copy not controlled: verify the version before using)</small>
	Classification level Public	Pages 133

- OE.LATENCY_CONTROL which ensure that the POS terminal implements time-out mechanisms that disables NFC transactions with low latency and thus detects such attack
- OE.NFC_PROTOCOL which ensures that payment transactions are disabled beyond a given distance
- OE.GUI_INST_ALERT which guarantees the legitimacy of installed GUIs
- OE.TRANSACTION_DISPLAY contributes in covering this threat by displaying related payment transaction information (amount, transaction status) on the screen of the customers mobile handset before or after the transaction

T.TRANSACTION_REPUDIATION This threat is countered by:

- O.DATA_USERS that prevents the use of the TOE by unauthorised users because they do not have the required rights to perform transactions
- O.USER_AUTH that requires the authentication of the customer before performing any transaction
- OE.TOE_USAGE which ensures that the Issuing Bank provides to the customer the rules to securely use his PAP and especially that he must not provide his Personal Code to anyone. Thus, if the Personal Code has been entered, kept secure and an authenticated communication has been used, the transaction cannot be repudiated.
- O.AUDIT ensures that the TOE shall record transactions to prevent from repudiation.

T.TRANSACTION_COUNTERFEITING This threat is covered by the following security objectives:

- O.DATA_USERS that prevents the use of the TOE by unauthorised users because they do not have the required rights to perform transactions
- O.AUTHORISATION_CONTROL which guarantees that the consistency of payment transactions is checked according to *Payez Mobile* specifications [PM-1]&[PM-2] before granting the customer the authorisation to submit payment transactions.
- O.RISK_MNGT which avoids improper conditions of using the PAP and ensures that only possible parameters values must be valid and correspond to secure configurations
- O.APP_BLOCK provides the means to authorised users to block the PAP in order to prevent from counterfeiting.
- O.USER_AUTH contributes in covering this threat by ensuring that only the customer can submit transactions.
- O.AUDIT ensures that the TOE shall record transactions to detect counterfeiting.
- O.TRANSACTION_BYPASS covers this threat by preventing from bypassing a mandatory step of the transaction flow model as defined by the [PM-1]&[PM-2] specifications and though preventing from counterfeiting of payment transactions.
- O.DATA_DISCLOSURE that guarantees the secrecy of the keys stored in the TOE.
- O.ISSUING_BANK_AUTH that ensures that nobody but the Issuing Bank can operate on PAP cryptographic keys stored in the TOE.
- OE.CERTIFICATES_MNGT that contributes in covering this threat by avoiding the usage of a counterfeited authentication certificates by providing updates.
- OE.MERCHANT_CONTROL ensures that the merchant maintains a specific security policy that ensures a secure usage of the POS terminal.

T.TRANSACTION_REPLAY This threat is covered by the following security objectives:

- O.TRANSACTION_REPLAY which ensures that replayed transactions will be detected and rejected by the TOE.
- O.TRANSACTION_UNIQUENESS which reserves the uniqueness of a transaction; this by limiting the probability of generating two identical copies of transactions certificates.
- O.USER_AUTH contributes in covering this threat by ensuring that only the customer can submit transactions.

	Reference D1270292	Release 1.01p <small>(Printed copy not controlled: verify the version before using)</small>
	Classification level Public	Pages 133

O.TRANSACTION_BYPASS covers this threat by preventing from bypassing a mandatory step of the transaction flow model as defined by the [PM-1]&[PM-2] specifications and though preventing from replaying a payment transaction.

O.SIM_UNLOCK requires unlocking the (U)SIM card (by means of the PIN code) for each payment transaction. This threat could be covered by the (U)SIM platform security functions;

5.3.1.4 DENIAL-OF-SERVICE

T.CERTIF_CORRUPTION This threat is covered by the security objective O.TRANSACTION_INTEGRITY that preserves the integrity of transactions and the integrity of all certified terms of the transactions.

The security objective O.TRANSACTION_UNIQUENESS contributes in covering this threat by preserving the uniqueness of a transaction by limiting the probability of generating two identical copies of transactions certificates.

T.APPLICATIONS_DOS This threat is covered by the following security objectives:

O.CHANNELS that provides the means to identify the origin of a communication request intended to be routed by a specific communication channel which decrease the probability of realizing such attacks

O.USER_AUTH contributes in covering this threat by ensuring that the customer is authenticated before performing a payment transaction

OE.GUI_INST_ALERT which guarantees the legitimacy of installed GUIs

O.GUIS_AUTH which ensures that the GUIs authorised to communicate with the applications of (U)SIM card are authenticated before granting them access to its functionalities; thus it prevents from such attacks.

	Reference D1270292	Release 1.01p <small>(Printed copy not controlled: verify the version before using)</small>
	Classification level Public	Pages 133

5.3.1.5 IDENTITY_USURPATION

T.MNO_USURPATION This threat is covered by the security objective O.TRANSACTION_BYPASS which prevent from bypassing a mandatory step of the transaction flow model as defined by the [PM-1]&[PM-2] specifications and though preventing from identity usurpation. O.MNO_AUTH contributes in covering this threat by ensuring that only the MNO can have access to its services.

T.ISSUING-BANK_USURPATION This threat is covered by the security objective O.TRANSACTION_BYPASS which prevent from bypassing a mandatory step of the transaction flow model as defined by the [PM-1]&[PM-2] specifications and though preventing from identity usurpation. O.ISSUING_BANK_AUTH contributes in covering this threat by ensuring that only the Issuing Bank can have access to its services.

T.CUSTOMER_USURPATION This threat is covered by the following security objectives:

O.TRANSACTION_BYPASS which prevent from bypassing a mandatory step of the transaction flow model as defined by the [PM] specifications and though preventing from identity usurpation

O.USER_AUTH contributes in covering this threat by ensuring that only the end user can have access to its services

O.AUDIT_ACCESS which guarantees that the end user has access to log files in order to check the history of payment transactions that he has made lately and thus prevents from identity usurpation

The security objective on the environment of the TOE OE.GUIS_TIMEOUT contributes to detect previous usurpation, in covering this threat by controlling Personal Code unsuccessful entry attempts.

5.3.2 Organisational Security Policies

5.3.2.1 HANDSET

OSP.POLICY This OSP is directly upheld by the security objective OE.POLICY.

OSP.CUSTOMER_PC_CONFID This OSP is directly upheld by the security objective OE.CUSTOMER_PC_CONFID.

OSP.GUIS_IDENTIFICATION This OSP is directly upheld by the security objective OE.GUIS_IDENTIFICATION.

5.3.2.2 MANAGEMENT

OSP.CERTIFICATES_MNGT This OSP is directly upheld by the security objective OE.CERTIFICATES_MNGT.

OSP.Contactless_life cycle_MNGT This OSP is directly upheld by the security objective OE.Contactless_life cycle_MNGT.

OSP.TOE_USAGE This OSP is directly upheld by the security objective OE.TOE_USAGE.

OSP.PISHING This security policy is covered by the security objective on the environment OE.NO_VAD which guarantees that only proximity purchase transactions are authorised.

	Reference D1270292	Release 1.01p <small>(Printed copy not controlled: verify the version before using)</small>
	Classification level Public	Pages 133

5.3.2.3 MERCHANT

OSP.MERCHANT_CONTROL This OSP is directly upheld by the security objective on the environment OE.MERCHANT_CONTROL. The security objectives on the environment OE.POS_APPROVAL and OE.POS_APPLICATIONS ensures that POS terminals accepting *Payez Mobile* payment transactions are approved by a reference body and that the contactless payment applications embedded in these POS terminals are protected in integrity and authenticity.

5.3.2.4 BANK

OSP.BANKS_PRIVILEGES This OSP is directly upheld by the security objective OE.BANKS_PRIVILEGES (refer to O.ISSUING_BANK_AUTH which requires the TOE to authenticate the Issuing Bank before processing administration transactions, and thus provide services only granted to the Issuing Bank, such as request or reset of counters.).

	Reference	D1270292	Release	1.01p <small>(Printed copy not controlled: verify the version before using)</small>
	Classification level	Public	Pages	133

5.3.3 Assumptions

A.MERCHANT_AUTH This assumption is enforced by the security objectives on the environment OE.MERCHANT_AUTH and OE.POS_APPLICATIONS which guarantees the authenticity of the merchant and the applications installed on the POS terminal handled by the merchant.

5.3.4 SPD and Security Objectives

Threats	Security Objectives	Rationale
T.DISCLOSURE_KEYS	OE.CERTIFICATES_MNGT , O.ISSUING_BANK_AUTH , O.DATA_DISCLOSURE	Section 5.3.1
T.DISCLOSURE_REF_PC	O.ISSUING_BANK_AUTH , O.USER_AUTH , O.DATA_DISCLOSURE	Section 5.3.1
T.INTEG_LOG_FILE	O.DATA_INTEGRITY , O.ISSUING_BANK_AUTH	Section 5.3.1
T.INTEG_KEYS	O.ISSUING_BANK_AUTH , O.DATA_INTEGRITY , O.USER_AUTH , O.MNO_AUTH	Section 5.3.1
T.INTEG_ACCOUNT_INFO	O.ISSUING_BANK_AUTH , O.DATA_INTEGRITY , O.USER_AUTH	Section 5.3.1
T.INTEG_REF_PC	O.ISSUING_BANK_AUTH , O.DATA_INTEGRITY , O.USER_AUTH	Section 5.3.1
T.INTEG_TRANS_PARAM	O.ISSUING_BANK_AUTH , O.DATA_INTEGRITY , O.TRANSACTION_BYPASS , O.USER_AUTH	Section 5.3.1
T.INTEG_COUNT	O.ISSUING_BANK_AUTH , O.DATA_INTEGRITY , O.TRANSACTION_BYPASS , O.USER_AUTH	Section 5.3.1
T.TEMPORARY_DATA	O.TRANSACTION_INTEGRITY , O.USER_AUTH , O.GUIS_AUTH , O.ISSUING_BANK_AUTH , O.DATA_INTEGRITY	Section 5.3.1
T.INTEG_SEL_ACT_PARAM	O.ISSUING_BANK_AUTH , O.DATA_INTEGRITY , O.USER_AUTH	Section 5.3.1
T.STEALING	OE.TOE_USAGE , O.RISK_MNGT , OE.CUSTOMER_PC_CONFID , OE.CERTIFICATES_MNGT , O.APP_BLOCK , O.USER_AUTH	Section 5.3.1
T.MERCHANT_ACCOMPLICE	O.SIM_UNLOCK , O.APP_BLOCK , OE.POS_DEACTIVATION , OE.MERCHANT_AUTH , OE.POS_APPLICATIONS , OE.POS_APPROVAL	Section 5.3.1
T.MAN-IN-THE-MIDDLE	O.CHANNELS , OE.NFC_PROTOCOL , OE.LATENCY_CONTROL , OE.GUI_INST_ALERT , OE.TRANSACTION_DISPLAY , O.USER_AUTH , O.AUDIT_ACCESS ,	Section 5.3.1

	Reference	D1270292	Release	1.01p (Printed copy not controlled: verify the version before using)
	Classification level	Public	Pages	133

Threats	Security Objectives	Rationale
	O.AUDIT	
T.TRANSACTION_REPUDIATION	O.DATA_USERS , OE.TOE_USAGE , O.USER_AUTH , O.AUDIT	Section 5.3.1
T.TRANSACTION_COUNTERFEITING	O.DATA_USERS , OE.CERTIFICATES_MNGT , O.AUTHORISATION_CONTROL , O.RISK_MNGT , OE.MERCHANT_CONTROL , O.APP_BLOCK , O.USER_AUTH , O.AUDIT , O.TRANSACTION_BYPASS , O.DATA_DISCLOSURE , O.ISSUING_BANK_AUTH	Section 5.3.1
T.TRANSACTION_REPLAY	O.TRANSACTION_REPLAY , O.TRANSACTION_UNIQUENESS , O.SIM_UNLOCK , O.USER_AUTH , O.TRANSACTION_BYPASS	Section 5.3.1
T.CERTIF_CORRUPTION	O.TRANSACTION_INTEGRITY , O.TRANSACTION_UNIQUENESS	Section 5.3.1
T.APPLICATIONS_DOS	O.CHANNELS , OE.GUI_INST_ALERT , O.USER_AUTH ,	Section 5.3.1
T.MNO_USURPATION	O.MNO_AUTH , O.TRANSACTION_BYPASS	Section 5.3.1
T.ISSUING-BANK_USURPATION	O.ISSUING_BANK_AUTH , O.TRANSACTION_BYPASS	Section 5.3.1
T.CUSTOMER_USURPATION	O.USER_AUTH , OE.GUIS_TIMEOUT , O.AUDIT_ACCESS , O.TRANSACTION_BYPASS	Section 5.3.1

Table 7: Threats and Security Objectives - Coverage

	Reference	D1270292	Release	1.01p (Printed copy not controlled: verify the version before using)
	Classification level	Public	Pages	133

Security Objectives	Threats
O.TRANSACTION_UNIQUENESS	T.TRANSACTION_REPLAY , T.CERTIF_CORRUPTION
O.TRANSACTION_INTEGRITY	T.TEMPORARY_DATA , T.CERTIF_CORRUPTION
O.TRANSACTION_BYPASS	T.INTEG_TRANS_PARAM , T.INTEG_COUNT , T.TRANSACTION_COUNTERFEITING , T.TRANSACTION_REPLAY , T.MNO_USURPATION , T.ISSUING-BANK_USURPATION , T.CUSTOMER_USURPATION
O.TRANSACTION_REPLAY	T.TRANSACTION_REPLAY
O.USER_AUTH	T.DISCLOSURE_REF_PC , T.INTEG_KEYS , T.INTEG_ACCOUNT_INFO , T.INTEG_REF_PC , T.INTEG_TRANS_PARAM , T.INTEG_COUNT , T.TEMPORARY_DATA , T.INTEG_SEL_ACT_PARAM , T.STEALING , T.MAN-IN-THE-MIDDLE , T.TRANSACTION_REPUDIATION , T.TRANSACTION_COUNTERFEITING , T.TRANSACTION_REPLAY , T.APPLICATIONS_DOS , T.CUSTOMER_USURPATION
O.ISSUING_BANK_AUTH	T.DISCLOSURE_KEYS , T.DISCLOSURE_REF_PC , T.INTEG_LOG_FILE , T.INTEG_KEYS , T.INTEG_ACCOUNT_INFO , T.INTEG_REF_PC , T.INTEG_TRANS_PARAM , T.INTEG_COUNT , T.TEMPORARY_DATA , T.INTEG_SEL_ACT_PARAM , T.ISSUING-BANK_USURPATION
O.MNO_AUTH	T.INTEG_KEYS , T.MNO_USURPATION
O.AUTHORISATION_CONTROL	T.TRANSACTION_COUNTERFEITING
O.DATA_DISCLOSURE	T.DISCLOSURE_KEYS , T.DISCLOSURE_REF_PC
O.DATA_INTEGRITY	T.INTEG_LOG_FILE , T.INTEG_KEYS , T.INTEG_ACCOUNT_INFO , T.INTEG_REF_PC , T.INTEG_TRANS_PARAM , T.INTEG_COUNT , T.TEMPORARY_DATA , T.INTEG_SEL_ACT_PARAM
O.DATA_USERS	T.TRANSACTION_REPUDIATION , T.TRANSACTION_COUNTERFEITING
O.RISK_MNGT	T.STEALING , T.TRANSACTION_COUNTERFEITING
O.APP_BLOCK	T.STEALING , T.MERCHANT_ACCOMPLICE , T.TRANSACTION_COUNTERFEITING
O.SIM_UNLOCK	T.MERCHANT_ACCOMPLICE ,

	Reference	D1270292	Release	1.01p (Printed copy not controlled: verify the version before using)
	Classification level	Public	Pages	133

Security Objectives	Threats
	T.TRANSACTION_REPLAY
O.AUDIT	T.TRANSACTION_REPUDIATION , T.TRANSACTION_COUNTERFEITING
O.CHANNELS	T.MAN-IN-THE-MIDDLE , T.APPLICATIONS_DOS
O.AUDIT_ACCESS	T.MAN-IN-THE-MIDDLE , T.CUSTOMER_USURPATION
O.GUIS_AUTH	T.INTEG_LOG_FILE T.INTEG_KEYS T.INTEG_ACCOUNT_INFO T.INTEG_REF_PC T.INTEG_TRANS_PARAM T.INTEG_COUNT T.INTEG_SEL_ACT_PARAM T.APPLICATIONS_DOS T.TEMPORARY_DATA
OE.CUSTOMER_PC_CONFID	T.STEALING
OE.GUI_INST_ALERT	T.MAN-IN-THE-MIDDLE , T.APPLICATIONS_DOS
OE.TOE_USAGE	T.STEALING , T.TRANSACTION_REPUDIATION
OE.GUIS_IDENTIFICATION	
OE.POLICY	
OE.NFC_PROTOCOL	T.MAN-IN-THE-MIDDLE
OE.TRANSACTION_DISPLAY	T.MAN-IN-THE-MIDDLE
OE.CHANNELS_SELECTION	
OE.GUIS_TIMEOUT	T.MAN-IN-THE-MIDDLE , T.CUSTOMER_USURPATION
OE.MERCHANT_CONTROL	T.TRANSACTION_COUNTERFEITING
OE.MERCHANT_AUTH	T.MERCHANT_ACCOMPLICE
OE.LATENCY_CONTROL	T.MAN-IN-THE-MIDDLE
OE.POS_APPROVAL	T.MERCHANT_ACCOMPLICE
OE.POS_APPLICATIONS	T.MERCHANT_ACCOMPLICE
OE.POS_DEACTIVATION	T.MERCHANT_ACCOMPLICE
OE.CERTIFICATES_MNGT	T.DISCLOSURE_KEYS , T.STEALING , T.TRANSACTION_COUNTERFEITING
OE.Contactless_life_cycle_MNGT	
OE.NO_VAD	
OE.BANKS_PRIVILEGES	

Table 8: Security Objectives and Threats - Coverage

	Reference D1270292	Release 1.01p <small>(Printed copy not controlled: verify the version before using)</small>
	Classification level Public	Pages 133

Organisational Security Policies	Security Objectives	Rationale
OSP.POLICY	OE.POLICY	Section 5.3.2
OSP.CUSTOMER_PC_CONFID	OE.CUSTOMER_PC_CONFID	Section 5.3.2
OSP.GUIS_IDENTIFICATION	OE.GUIS_IDENTIFICATION	Section 5.3.2
OSP.CERTIFICATES_MNGT	OE.CERTIFICATES_MNGT	Section 5.3.2
OSP.Contactless_life cycle_MNGT	OE.Contactless_life cycle_MNGT	Section 5.3.2
OSP.TOE_USAGE	OE.TOE_USAGE	Section 5.3.2
OSP.PISHING	OE.NO_VAD	Section 5.3.2
OSP.MERCHANT_CONTROL	OE.MERCHANT_CONTROL , OE.POS_APPROVAL , OE.POS_APPLICATIONS	Section 5.3.2
OSP.BANKS_PRIVILEGES	OE.BANKS_PRIVILEGES	Section 5.3.2

Table 9: OSPs and Security Objectives - Coverage

	Reference	D1270292	Release	1.01p <small>(Printed copy not controlled: verify the version before using)</small>
	Classification level	Public	Pages	133

Security Objectives	Organisational Security Policies
O.TRANSACTION_UNIQUENESS	
O.TRANSACTION_INTEGRITY	
O.TRANSACTION_BYPASS	
O.TRANSACTION_REPLAY	
O.USER_AUTH	
O.ISSUING_BANK_AUTH	
O.MNO_AUTH	
O.AUTHORISATION_CONTROL	
O.DATA_DISCLOSURE	
O.DATA_INTEGRITY	
O.DATA_USERS	
O.RISK_MNGT	
O.APP_BLOCK	
O.SIM_UNLOCK	
O.AUDIT	
O.CHANNELS	
O.AUDIT_ACCESS	
O.GUIS_AUTH	
OE.CUSTOMER_PC_CONFID	OSP.CUSTOMER_PC_CONFID
OE.GUI_INST_ALERT	
OE.TOE_USAGE	OSP.TOE_USAGE
OE.GUIS_IDENTIFICATION	OSP.GUIS_IDENTIFICATION
OE.POLICY	OSP.POLICY
OE.NFC_PROTOCOL	
OE.TRANSACTION_DISPLAY	
OE.CHANNELS_SELECTION	
OE.GUIS_TIMEOUT	
OE.MERCHANT_CONTROL	OSP.MERCHANT_CONTROL
OE.MERCHANT_AUTH	
OE.LATENCY_CONTROL	
OE.POS_APPROVAL	OSP.MERCHANT_CONTROL
OE.POS_APPLICATIONS	OSP.MERCHANT_CONTROL
OE.POS_DEACTIVATION	
OE.CERTIFICATES_MNGT	OSP.CERTIFICATES_MNGT
OE.Contactless_life cycle_MNGT	OSP.Contactless_life cycle_MNGT
OE.NO_VAD	OSP.PISHING
OE.BANKS_PRIVILEGES	OSP.BANKS_PRIVILEGES

Table 10: Security Objectives and OSPs - Coverage

	Reference	D1270292	Release	1.01p <small>(Printed copy not controlled: verify the version before using)</small>
	Classification level	Public	Pages	133

Assumptions	Security Objectives for the Operational Environment	Rationale
A.MERCHANT_AUTH	OE.MERCHANT_AUTH , OE.POS_APPLICATIONS	Section 5.3.3

Table 11: Assumptions and Security Objectives for the Operational Environment - Coverage

Security Objectives for the Operational Environment	Assumptions
OE.CUSTOMER_PC_CONFID	
OE.GUI_INST_ALERT	
OE.TOE_USAGE	
OE.GUIS_IDENTIFICATION	
OE.POLICY	
OE.NFC_PROTOCOL	
OE.TRANSACTION_DISPLAY	
OE.CHANNELS_SELECTION	
OE.GUIS_TIMEOUT	
OE.MERCHANT_CONTROL	
OE.MERCHANT_AUTH	A.MERCHANT_AUTH
OE.LATENCY_CONTROL	
OE.POS_APPROVAL	
OE.POS_APPLICATIONS	A.MERCHANT_AUTH
OE.POS_DEACTIVATION	
OE.CERTIFICATES_MNGT	
OE.Contactless life cycle MNGT	
OE.NO_VAD	
OE.BANKS_PRIVILEGES	

Table 12: Security Objectives for the Operational Environment and Assumptions - Coverage

	Reference	D1270292	Release	1.01p <small>(Printed copy not controlled: verify the version before using)</small>
	Classification level	Public	Pages	133

6 Security Requirements

6.1 Security Functional Requirements

This section defines the security functional requirements (SFR) and the EAL. It provides the rationale between security objectives and SFRs, and the SFRs dependencies rationale.

The following two tables define the operations and security attributes involved in the Access Control and Information Control Policies for the product. The subjects, objects and information are given together with the definition of each particular policy.

Operation	Access Control SFP	Information Flow Control SFP
PAP Selection	PAP Application / PAP Activation	
PAP Activation/Deactivation - PAP Locking/Unlocking	PAP Application / PAP Administration Management	
Systematic Personal Code Activation	PAP Application / PAP Administration Management	
Personal Code Presentation for Payment	PAP Application / PAP Payment Transaction Management	
Personal Code Verification	PAP Application / PAP Payment Transaction Management	
Log Update	PAP Application / PAP Payment Transaction Management	
Log Reading	PAP Application / PAP Administration Management	
Reference Personal Code Change/Unblock	PAP Application / PAP Administration Management	
Counter Reset	PAP Application / Post-Issuance Bank Management	Post-Issuance Bank Management
Audit (Log creation)	PAP Application / Post-Issuance Bank Management	Post-Issuance Bank Management
PAP Offline Data Authentication	PAP Application / PAP Offline Authentication / PAP Transaction	PAP Offline Authentication
PAP Action Analysis	PAP Application / PAP Transaction	PAP Offline Transaction / PAP Online Transaction
PAP Offline Transaction	PAP Application / PAP Transaction	PAP Offline Transaction
PAP Online Transaction	PAP Application / PAP Transaction	PAP Online Transaction
Issuing Bank Script Processing	Post-Issuance Bank Management	Post-Issuance Bank Management

	Reference D1270292	Release 1.01p <small>(Printed copy not controlled: verify the version before using)</small>
	Classification level Public	Pages 133

Security Attributes	Values
Contactless Life Cycle State	INSTALLED - ACTIVATED / DEACTIVATED - NON-ACTIVATABLE – LOCKED
(U)SIM Card Life Cycle Status	SELECTED / BLOCKED / NOT BLOCKED
PAP Transaction Processing State	Complies with [PM-1]&[PM-2] and indicates results of transaction processing steps / Does not comply with [PM-1]&[PM-2]
PAP Transaction Parameters Integrity	VERIFIED / NOT VERIFIED / CORRUPTED
PAP Transaction Parameters State	Issuing Bank risk management parameter value
PAP Keys Integrity	VERIFIED / NOT VERIFIED / CORRUPTED
PAP Reference Personal Code State	BLOCKED / UNBLOCKED
Systematic Personal Code State	ENABLED / DISABLED
PAP Reference Personal Code Integrity	VERIFIED / NOT VERIFIED / CORRUPTED
PAP Personal Code State	VERIFIED / NOT VERIFIED / ALWAYS REQUESTED / REQUESTED AT THE NEXT PAYMENT
PAP Personal Code Entry Amount	GREATER / LESSER THAN PERSONAL CODE ENTRY LIMIT VALUE
PAP Customer Account Information Integrity	VERIFIED / NOT VERIFIED / CORRUPTED
Log File Reading Status	PERMITTED (Log entry data is present) / NOT PERMITTED
Log File Update Status	ALLOWED / NOT ALLOWED
PAP Counters Integrity	VERIFIED / NOT VERIFIED / Corrupted
PAP Counters State	COUNTER IN RANGE / BLOCKED
PAP Selection and Activation Parameters	VERIFIED / NOT VERIFIED / CORRUPTED
Issuing Bank Transaction Data Integrity and Origin	VERIFIED / NOT VERIFIED / CORRUPTED
Issuing Bank Transaction Data Confidentiality, Integrity and Origin	VERIFIED / NOT VERIFIED / CORRUPTED
PAP Action Analysis State	Results of the PAP Action Analysis
PAP Risk Management Parameters Integrity	VERIFIED / NOT VERIFIED / CORRUPTED

	Reference	D1270292	Release	1.01p <small>(Printed copy not controlled: verify the version before using)</small>
	Classification level	Public	Pages	133

6.1.1 ACCESS CONTROL POLICY

FDP_ACC.2/ PAP Application Complete access control

FDP_ACC.2.1/ PAP Application The TSF shall enforce the **PAP Application Access Control SFP** on **S.PAP, PAP State Machine** and all operations among subjects and objects covered by the SFP.

FDP_ACC.2.2/ PAP Application The TSF shall ensure that all operations between any subject controlled by the TSF and any object controlled by the TSF are covered by an access control SFP.

Application Note: What follows are all operations among subjects and objects covered by this SFP:

PAP Selection
PAP Activation/Deactivation
PAP Locking/Unlocking
Systematic Personal Code Activation
Personal Code Presentation for Payment
Personal Code Verification
Log Update
Log Reading
Reference Personal Code Change/Unblock
Counter Reset
Audit
PAP Offline Data Authentication
PAP Action Analysis
PAP Offline Transaction
PAP Online Transaction
Issuing Bank Script Processing

FDP_ACC.2/ PAP Activation Complete access control

FDP_ACC.2.1/ PAP Activation The TSF shall enforce the **PAP Activation Access Control SFP** on **S.PAP;**
PAP Transaction Parameters;
PAP Selection and Activation Parameters
and all operations among subjects and objects covered by the SFP.

FDP_ACC.2.2/ PAP Activation The TSF shall ensure that all operations between any subject controlled by the TSF and any object controlled by the TSF are covered by an access control SFP.

Application Note: What follows are all operations among subjects and objects covered by this SFP:

PAP Selection

	Reference	D1270292	Release	1.01p <small>(Printed copy not controlled: verify the version before using)</small>
	Classification level	Public	Pages	133

FDP_ACC.2/ PAP Administration Management Complete access control

FDP_ACC.2.1/ PAP Administration Management The TSF shall enforce the **PAP Administration Management Access Control SFP** on

Subject:

S.PAP;

Objects:

PAP Selection and Activation Parameters;

PAP Log File;

PAP Keys;

PAP Counters;

Personal Code and Reference Personal Code

and all operations among subjects and objects covered by the SFP.

FDP_ACC.2.2/ PAP Administration Management The TSF shall ensure that all operations between any subject controlled by the TSF and any object controlled by the TSF are covered by an access control SFP.

Application Note: What follows are all operations among subjects and objects covered by this SFP:

PAP Activation/Deactivation

PAP Locking/Unlocking

Systematic Personal Code Activation

Log Reading

Reference Personal Code Change/Unblock

FDP_ACC.2/ PAP Payment Transaction Management Complete access control

FDP_ACC.2.1/ PAP Payment Transaction Management The TSF shall enforce the **PAP Payment Transaction Management Access Control SFP** on

Subjects:

S.PAP;

S.BANK_TSM;

S.MNO_ISD;

Objects:

Personal Code;

PAP Log File,

and all operations among subjects and objects covered by the SFP.

FDP_ACC.2.2/ PAP Payment Transaction Management The TSF shall ensure that all operations between any subject controlled by the TSF and any object controlled by the TSF are covered by an access control SFP.

Application Note: What follows are all operations among subjects and objects covered by this SFP:

Personal Code Presentation for Payment

Personal Code Verification

Log Update

	Reference	D1270292	Release	1.01p <small>(Printed copy not controlled: verify the version before using)</small>
	Classification level	Public	Pages	133

FDP_ACC.2/ Post-Issuance Bank Management Complete access control

FDP_ACC.2.1/ Post-Issuance Bank Management The TSF shall enforce the **Post-Issuance Bank Management Access Control SFP** on

Subjects:

S.PAP;
S.BANK_TSM;
S.MNO_ISD;

Objects:

Issuing Bank Transaction Data;
Issuing Bank Scripts;
PAP Counters;
PAP Keys;
PAP Selection and Activation Parameters;
PAP Transaction Parameters;
PAP Log File

and all operations among subjects and objects covered by the SFP.

FDP_ACC.2.2/ Post-Issuance Bank Management The TSF shall ensure that all operations between any subject controlled by the TSF and any object controlled by the TSF are covered by an access control SFP.

Application Note: What follows are all operations among subjects and objects covered by this SFP:

Counter Reset

Audit

Issuing Bank Script Processing

FDP_ACC.2/ PAP Offline Authentication Complete access control

FDP_ACC.2.1/ PAP Offline Authentication The TSF shall enforce the **PAP Offline Authentication control access SFP** on

Subject:

S.PAP;

Objects:

PAP Keys;
PAP Transaction Parameters;
PAP State Machine

and all operations among subjects and objects covered by the SFP.

FDP_ACC.2.2/ PAP Offline Authentication The TSF shall ensure that all operations between any subject controlled by the TSF and any object controlled by the TSF are covered by an access control SFP.

Application Note: What follows are all operations among subjects and objects covered by this SFP:

PAP Offline Data Authentication

	Reference	D1270292	Release	1.01p <small>(Printed copy not controlled: verify the version before using)</small>
	Classification level	Public	Pages	133

FDP_ACC.2/ PAP Transaction Complete access control

FDP_ACC.2.1/ PAP Transaction The TSF shall enforce the **PAP Transaction Access Control SFP** on

Subject:

S.PAP;

Objects;

Customer Account Information;

PAP Counters;

PAP Keys;

PAP State Machine;

PAP Transaction Parameters

and all operations among subjects and objects covered by the SFP.

FDP_ACC.2.2/ PAP Transaction The TSF shall ensure that all operations between any subject controlled by the TSF and any object controlled by the TSF are covered by an access control SFP.

Application Note: What follows are all operations among subjects and objects covered by this SFP:

PAP Offline Data Authentication

PAP Action Analysis

PAP Offline Transaction

PAP Online Transaction

PAP Transaction processing is defined by above operations.

6.1.2 ACCESS CONTROL FUNCTIONS

FDP_ACF.1/ PAP Application Security attribute based access control

FDP_ACF.1.1/ PAP Application The TSF shall enforce the **PAP Application Access Control SFP** to objects based on the following:

Security attributes of the object PAP State Machine:

Contactless Life Cycle State;

(U)SIM Card Life Cycle Status.

	Reference	D1270292	Release	1.01p <small>(Printed copy not controlled: verify the version before using)</small>
	Classification level	Public	Pages	133

FDP_ACF.1.2/ PAP Application The TSF shall enforce the following rules to determine if an operation among controlled subjects and controlled objects is allowed:

PAP operations are allowed only if the:

**Contactless Life Cycle State is ACTIVATED or DEACTIVATED;
(U)SIM Card Life Cycle Status is NOT BLOCKED.**

FDP_ACF.1.3/ PAP Application The TSF shall explicitly authorise access of subjects to objects based on the following additional rules: **none.**

FDP_ACF.1.4/ PAP Application The TSF shall explicitly deny access of subjects to objects based on the following additional rules:

If one of the conditions listed in FDP_ACF.1.2 is not fulfilled.

FDP_ACF.1/ PAP Activation Security attribute based access control
--

FDP_ACF.1.1/ PAP Activation The TSF shall enforce the **PAP Activation Access Control SFP** to objects based on the following:

Security attributes of the subject S.PAP:

Contactless Life Cycle State;

Security attributes of the object PAP Selection and Activation Parameters:

PAP Selection and Activation Parameters;

Security attributes of the object PAP Transaction Parameters:

PAP Transaction Parameters Integrity.

FDP_ACF.1.2/ PAP Activation The TSF shall enforce the following rules to determine if an operation among controlled subjects and controlled objects is allowed:

Selection is allowed only if:

Contactless Life Cycle State is INSTALLED;

PAP Selection and Activation Parameters is allowed only if:

PAP Selection and Activation Parameters is VERIFIED;

PAP Transaction Parameters is allowed only if:

PAP Transaction Parameters Integrity is VERIFIED.

FDP_ACF.1.3/ PAP Activation The TSF shall explicitly authorise access of subjects to objects based on the following additional rules:

None.

FDP_ACF.1.4/ PAP Activation The TSF shall explicitly deny access of subjects to objects based on the following additional rules: **following rule:**

If one of the conditions listed in FDP_ACF.1.2 and FDP_ACF.1.3 is not fulfilled.

	Reference	D1270292	Release	1.01p <small>(Printed copy not controlled: verify the version before using)</small>
	Classification level	Public	Pages	133

FDP_ACF.1/ PAP Administration Management Security attribute based access control

FDP_ACF.1.1/ PAP Administration Management The TSF shall enforce the **PAP Administration Management Access Control SFP** to objects based on the following:

Security attributes of the object Personal Code and Reference Personal Code:

- PAP Reference Personal Code State;
- PAP Reference Personal Code Integrity;
- PAP Personal Code State;

Security attributes of the subject S.PAP:

- Contactless Life Cycle State;

Security attributes of the object PAP Log File:

- Log File Reading Status;

Security attributes of the object PAP Keys:

- PAP Keys Integrity;

Security attributes of the object PAP Counters:

- PAP Counters Integrity;
- PAP Counters State.

FDP_ACF.1.2/ PAP Administration Management The TSF shall enforce the following rules to determine if an operation among controlled subjects and controlled objects is allowed:

Systematic Personal Code Activation/Deactivation is allowed only if:

- PAP Reference Personal Code Integrity is VERIFIED;
- PAP Personal Code State is VERIFIED;

Reference Personal Code Change/Unblock is allowed only if:

- PAP Reference Personal Code Integrity is VERIFIED;
- PAP Personal Code State is VERIFIED;
- PAP Reference Personal Code State is UNBLOCKED;

Log Reading is allowed only if:

- Contactless Life Cycle State is ACTIVATED or DEACTIVATED;
- Log File Reading Status is PERMITTED (Log entry data is present);

PAP Activation/Deactivation is allowed only if:

- Contactless Life Cycle State is ACTIVATED or DEACTIVATED;
- PAP Reference Personal Code State Integrity is VERIFIED;
- PAP Personal Code State is VERIFIED;

PAP Locking/Unlocking is allowed only if:

- PAP (Issuing Bank) Keys Integrity is VERIFIED;
- PAP (Issuing Bank secure script) Counters Integrity is VERIFIED;
- PAP (Issuing Bank secure script) Counters State is NOT BLOCKED.

FDP_ACF.1.3/ PAP Administration Management The TSF shall explicitly authorise access of subjects to objects based on the following additional rules: **none**.

FDP_ACF.1.4/ PAP Administration Management The TSF shall explicitly deny access of subjects to objects based on the following additional rules: **following rule:**

If one of the conditions listed in FDP_ACF.1.2 is not fulfilled.

	Reference	D1270292	Release	1.01p <small>(Printed copy not controlled: verify the version before using)</small>
	Classification level	Public	Pages	133

FDP_ACF.1/ PAP Payment Transaction Management Security attribute based access control

FDP_ACF.1.1/ PAP Payment Transaction Management The TSF shall enforce the **PAP Payment Transaction Management Access Control SFP** to objects based on the following:

Security attributes of the object Personal Code:

- PAP Reference Personal Code State;
- PAP Reference Personal Code Integrity;
- PAP Personal Code State;
- PAP Personal Code Entry Amount;
- Systematic Personal Code State;

Security attributes of the object PAP Log File:

- Log File Update Status.

FDP_ACF.1.2/ PAP Payment Transaction Management The TSF shall enforce the following rules to determine if an operation among controlled subjects and controlled objects is allowed:

Personal Code Verification is allowed only if:

- PAP Reference Personal Code State is **UNBLOCKED**;
- PAP Reference Personal Code Integrity is **VERIFIED**;

Personal Code Presentation for Payment is requested only if:

- PAP Personal Code State is **NOT VERIFIED** (by the Bank's GUI) or **ALWAYS REQUESTED** or **REQUESTED AT THE NEXT PAYMENT**;
- PAP Personal Code Entry Amount is **GREATER THAN PERSONAL CODE ENTRY LIMIT VALUE** or the **Systematic Personal Code State** is **ENABLED**;

PAP Log File is allowed for all transactions besides those of Post-Issuance Bank Management (only during payment transactions):

- Log File Update Status is **ALLOWED**

FDP_ACF.1.3/ PAP Payment Transaction Management The TSF shall explicitly authorise access of subjects to objects based on the following additional rules: **none**.

FDP_ACF.1.4/ PAP Payment Transaction Management The TSF shall explicitly deny access of subjects to objects based on the following additional rules: **following rule:**

If one of the conditions listed in FDP_ACF.1.2 is not fulfilled.

FDP_ACF.1/ Post-Issuance Bank Management Security attribute based access control

FDP_ACF.1.1/ Post-Issuance Bank Management The TSF shall enforce the **Post-Issuance Bank Management Access Control SFP** to objects based on the following:

Security attributes of the object PAP Keys:

- PAP Keys Integrity;

Security attributes of the object PAP Counters:

- PAP Counters Integrity;
- PAP Counters State;

Security attributes of the object PAP Transaction Parameters:

- PAP Transaction Parameters Integrity;

	Reference	D1270292	Release	1.01p <small>(Printed copy not controlled: verify the version before using)</small>
	Classification level	Public	Pages	133

Security attributes of the object Issuing Bank Transaction Data:

Issuing Bank Transaction Data Integrity and Origin;

Issuing Bank Transaction Data Confidentiality, Integrity and Origin.

FDP_ACF.1.2/ Post-Issuance Bank Management The TSF shall enforce the following rules to determine if an operation among controlled subjects and controlled objects is allowed:

Post-Issuance Bank Management operations are allowed only if:

PAP (Issuing Bank) Keys Integrity is VERIFIED;

PAP (Issuing Bank secure script) Counters Integrity is VERIFIED;

PAP (Issuing Bank secure script) Counters State is NOT BLOCKED;

Issuing Bank Transaction Data Integrity and Origin is VERIFIED;

Issuing Bank Transaction Data Confidentiality, Integrity and Origin is VERIFIED;

PAP Transaction Parameters Integrity is VERIFIED;

FDP_ACF.1.3/ Post-Issuance Bank Management The TSF shall explicitly authorise access of subjects to objects based on the following additional rules: **None.**

FDP_ACF.1.4/ Post-Issuance Bank Management The TSF shall explicitly deny access of subjects to objects based on the following additional rules: **following rule:**

If one of the conditions listed in FDP_ACF.1.2 is not fulfilled.

FDP_ACF.1/ PAP Offline Authentication Security attribute based access control
--

FDP_ACF.1.1/ PAP Offline Authentication The TSF shall enforce the **PAP Offline Authentication Access Control SFP** to objects based on the following:

Security attributes of the subject S.PAP:

Contactless Life Cycle State;

(U)SIM Card Life Cycle Status;

Security attributes of the object PAP State Machine:

PAP Transaction Processing State;

Security attributes of the object PAP Keys:

PAP Keys Integrity;

Security attributes of the object PAP Transaction Parameters:

PAP Transaction Parameters State;

PAP Transaction Parameters Integrity.

FDP_ACF.1.2/ PAP Offline Authentication The TSF shall enforce the following rules to determine if an operation among controlled subjects and controlled objects is allowed:

PAP Offline Data Authentication is allowed only if:

	Reference	D1270292	Release	1.01p <small>(Printed copy not controlled: verify the version before using)</small>
	Classification level	Public	Pages	133

(U)SIM Card Life Cycle Status is SELECTED;
Contactless Life Cycle State is ACTIVATED;
PAP Transaction Processing State complies with Transaction Flow;
PAP Keys Integrity is VERIFIED;
PAP Transaction Parameters Integrity is VERIFIED;
PAP Transaction Parameters State indicates a dynamic authentication process.

FDP_ACF.1.3/ PAP Offline Authentication The TSF shall explicitly authorise access of subjects to objects based on the following additional rules: **None**.

FDP_ACF.1.4/ PAP Offline Authentication The TSF shall explicitly deny access of subjects to objects based on the following additional rules: **following rule:**
If one of the conditions listed in FDP_ACF.1.2 is not fulfilled.

FDP_ACF.1/ PAP Transaction Security attribute based access control

FDP_ACF.1.1/ PAP Transaction The TSF shall enforce the **PAP Transaction Access Control SFP** to objects based on the following:

Security attributes of the object PAP State Machine:

PAP Transaction Processing State;

Security attributes of the subject S.PAP:

Contactless Life Cycle State;

Security attributes of the object PAP Counters:

PAP Counters Integrity;

Security attributes of the object PAP Keys:

PAP Keys Integrity;

Security attributes of the object Customer Account Information:

PAP Customer Account Information Integrity (PAN integrity);

Security attributes of the object PAP Transaction Parameters:

PAP Transaction Parameters Integrity.

FDP_ACF.1.2/ PAP Transaction The TSF shall enforce the following rules to determine if an operation among controlled subjects and controlled objects is allowed:

PAP Transaction processing is allowed only if:

	Reference	D1270292	Release	1.01p <small>(Printed copy not controlled: verify the version before using)</small>
	Classification level	Public	Pages	133

(U)SIM Card Life Cycle Status is **SELECTED**;
Contactless Life Cycle State **ACTIVATED**;
PAP Transaction Processing State complies with **Transaction Flows**;
PAP Counters Integrity is **VERIFIED**;
PAP Counters State is not **BLOCKED**;
PAP Customer Account Information Integrity is **VERIFIED**;
PAP Risk Management Parameters Integrity is **VERIFIED**;

FDP_ACF.1.3/ PAP Transaction The TSF shall explicitly authorise access of subjects to objects based on the following additional rules: **None**.

FDP_ACF.1.4/ PAP Transaction The TSF shall explicitly deny access of subjects to objects based on the following additional rules: **following rule**:

If one of the conditions listed in FDP_ACF.1.2 is not fulfilled.

6.1.3 INFORMATION FLOW CONTROL POLICY

FDP_IFC.2/ PAP Offline Authentication Complete information flow control

FDP_IFC.2.1/ PAP Offline Authentication The TSF shall enforce the **PAP Offline Authentication information flow control SFP** on

Subjects:

S.PAP;

Information:

PAP Transaction Parameters;

and all operations that cause that information to flow to and from subjects covered by the SFP.

FDP_IFC.2.2/ PAP Offline Authentication The TSF shall ensure that all operations that cause any information in the TOE to flow to and from any subject in the TOE are covered by an information flow control SFP.

Application Note: What follows are all operations among subjects and objects covered by this SFP:

PAP Offline Data Authentication

FDP_IFC.2/ PAP Offline Transaction Complete information flow control

FDP_IFC.2.1/ PAP Offline Transaction The TSF shall enforce the **PAP Offline Transaction Information Flow Control SFP** on

Subject:

S.PAP;

Information:

PAP Transaction Parameters;

and all operations that cause that information to flow to and from subjects covered by the SFP.

	Reference D1270292	Release 1.01p <small>(Printed copy not controlled: verify the version before using)</small>
	Classification level Public	Pages 133

FDP_IFC.2.2/ PAP Offline Transaction The TSF shall ensure that all operations that cause any information in the TOE to flow to and from any subject in the TOE are covered by an information flow control SFP.

Application Note: What follows are all operations among subjects and objects covered by this SFP:

PAP Action Analysis

PAP Offline Transaction

FDP_IFC.2/ PAP Online Transaction Complete information flow control
--

FDP_IFC.2.1/ PAP Online Transaction The TSF shall enforce the **PAP Online Transaction information flow control SFP** on

Subject:

S.PAP;

Information:

PAP Transaction Parameters;

Issuing Bank Transaction Data

and all operations that cause that information to flow to and from subjects covered by the SFP.

FDP_IFC.2.2/ PAP Online Transaction The TSF shall ensure that all operations that cause any information in the TOE to flow to and from any subject in the TOE are covered by an information flow control SFP.

Application Note: What follows are all operations among subjects and objects covered by this SFP:

PAP Action Analysis

PAP Online Transaction

FDP_IFC.2/ Post-Issuance Bank Management Complete information flow control

FDP_IFC.2.1/ Post-Issuance Bank Management The TSF shall enforce the **Post-Issuance Bank Management information flow control SFP** on

Subject:

S.PAP;

Information:

Issuing Bank Transaction Data;

and all operations that cause that information to flow to and from subjects covered by the SFP.

FDP_IFC.2.2/ Post-Issuance Bank Management The TSF shall ensure that all operations that cause any information in the TOE to flow to and from any subject in the TOE are covered by an information flow control SFP.

Application Note: What follows are all operations among subjects and objects covered by this SFP:

Counter Reset

Audit

Issuing Bank Script Processing

	Reference	D1270292	Release	1.01p <small>(Printed copy not controlled: verify the version before using)</small>
	Classification level	Public	Pages	133

FDP_IFF.1/ PAP Offline Authentication Simple security attributes

FDP_IFF.1.1/ PAP Offline Authentication The TSF shall enforce the **PAP Offline Authentication information flow control SFP** based on the following types of subject and information security attributes:

Security Attributes of the subject S.PAP:

Contactless Life Cycle State;

Security Attributes of the information PAP Transaction Parameters:

PAP Transaction Parameters State.

FDP_IFF.1.2/ PAP Offline Authentication The TSF shall permit an information flow between a controlled subject and controlled information via a controlled operation if the following rules hold:

S.PAP is the currently selected application;

Contactless Life Cycle State is ACTIVATED;

PAP Transaction Parameters State requires dynamic authentication.

FDP_IFF.1.3/ PAP Offline Authentication The TSF shall enforce the **following rules: none.**

FDP_IFF.1.4/ PAP Offline Authentication The TSF shall explicitly authorise an information flow based on the following rules: **None.**

FDP_IFF.1.5/ PAP Offline Authentication The TSF shall explicitly deny an information flow based on the following rules:

If one of the conditions listed in FDP_IFF.1.2 is not fulfilled.

FDP_IFF.1/ PAP Offline Transaction Simple security attributes

FDP_IFF.1.1/ PAP Offline Transaction The TSF shall enforce the **PAP Offline Transaction information flow control SFP** based on the following types of subject and information security attributes:

Security Attributes of the subject S.PAP:

Contactless Life Cycle State;

PAP Action Analysis State;

Security Attributes of the information PAP Transaction Parameters:

PAP Transaction Processing State.

	Reference	D1270292	Release	1.01p <small>(Printed copy not controlled: verify the version before using)</small>
	Classification level	Public	Pages	133

FDP_IFF.1.2/ PAP Offline Transaction The TSF shall permit an information flow between a controlled subject and controlled information via a controlled operation if the following rules hold:

- S.PAP is the currently selected application;**
- Contactless Life Cycle State is ACTIVATED;**
- PAP Transaction Processing State complies with [PM-1] & [PM-2];**
- PAP Action Analysis State requires offline processing;**
- PAP Action Analysis State does not reject the transaction.**

FDP_IFF.1.3/ PAP Offline Transaction The TSF shall enforce the following rules: **None.**

FDP_IFF.1.4/ PAP Offline Transaction The TSF shall explicitly authorise an information flow based on the following rules: **none.**

FDP_IFF.1.5/ PAP Offline Transaction The TSF shall explicitly deny an information flow based on the following rules:

- If one of the conditions listed in FDP_IFF.1.2 is not fulfilled.**

FDP_IFF.1/ PAP Online Transaction Simple security attributes

FDP_IFF.1.1/ PAP Online Transaction The TSF shall enforce the **PAP Online Transaction information flow control SFP** based on the following types of subject and information security attributes:

- Security Attributes of the subject S.PAP:**
 - Contactless Life Cycle State;**
 - PAP Action Analysis State;**
- Security Attributes of the information PAP Transaction parameters:**
 - PAP Transaction Processing State;**
- Security Attributes of the information Issuing Bank Transaction data:**
 - Issuing Bank Transaction Data Integrity and Origin;**

	Reference	D1270292	Release	1.01p <small>(Printed copy not controlled: verify the version before using)</small>
	Classification level	Public	Pages	133

FDP_IFF.1.2/ PAP Online Transaction The TSF shall permit an information flow between a controlled subject and controlled information via a controlled operation if the following rules hold:

- S.PAP is the currently selected application;**
- Contactless Life Cycle is ACTIVATED;**
- PAP Transaction Processing State complies with [PM-1] & [PM-2];**
- PAP Action Analysis State requires online processing;**
- PAP Action Analysis State does not reject the transaction;**
- Issuing Bank Transaction Data Integrity and Origin is VERIFIED;**

FDP_IFF.1.3/ PAP Online Transaction The TSF shall enforce the **following rules: None.**

FDP_IFF.1.4/ PAP Online Transaction The TSF shall explicitly authorise an information flow based on the following rules: **None.**

FDP_IFF.1.5/ PAP Online Transaction The TSF shall explicitly deny an information flow based on the following rules:

- If one of the conditions listed in FDP_IFF.1.2 is not fulfilled.**

FDP_IFF.1/ Post-Issuance Bank Management Simple security attributes
--

FDP_IFF.1.1/ Post-Issuance Bank Management The TSF shall enforce the **Post-Issuance Bank Management information flow control SFP** based on the following types of subject and information security attributes:

- Security Attributes of the subject S.PAP:**
 - Contactless Life Cycle State;**
- Security Attributes of the information Issuing Bank Transaction Data:**
 - Issuing Bank Transaction Data Confidentiality, Integrity and Origin.**

FDP_IFF.1.2/ Post-Issuance Bank Management The TSF shall permit an information flow between a controlled subject and controlled information via a controlled operation if the following rules hold:

- S.PAP is the currently selected application;**
- Contactless Life Cycle is ACTIVATED or DEACTIVATED;**
- PAP Action Analysis State does not reject the transaction;**
- Issuing Bank Transaction Data Confidentiality, Integrity and Origin is VERIFIED.**

FDP_IFF.1.3/ Post-Issuance Bank Management The TSF shall enforce the **following rules: None.**

FDP_IFF.1.4/ Post-Issuance Bank Management The TSF shall explicitly authorise an information flow based on the following rules: **None.**

FDP_IFF.1.5/ Post-Issuance Bank Management The TSF shall explicitly deny an information flow based on the following rules:

- If one of the conditions listed in FDP_IFF.1.2 is not fulfilled.**

	Reference	D1270292	Release	1.01p <small>(Printed copy not controlled: verify the version before using)</small>
	Classification level	Public	Pages	133

6.1.4 SECURITY AUDIT

FAU_ARP.1 Security alarms

FAU_ARP.1.1 The TSF shall take **one of the following actions:**

- locking the PAP;**
- blocking or terminating the (U)SIM card session (muting the (U)SIM card);**
- reinitializing secret data;**
- bringing the (U)SIM card to a secure state;**
- temporary disabling the services of the PAP until a privileged role performs a special action;**
- definitely disabling all the services of the PAP**

upon detection of a potential security violation.

FAU_SAA.1 Potential violation analysis

FAU_SAA.1.1 The TSF shall be able to apply a set of rules in monitoring the audited events and based upon these rules indicate a potential violation of the enforcement of the SFRs.

FAU_SAA.1.2 The TSF shall enforce the following rules for monitoring audited events:

- a) Accumulation or combination of **the following auditable events:**
 - unauthorised use of the PAP services;**
 - unauthorised read or modification of the PAP sensitive assets protected in integrity and confidentiality;**
 - unauthorised modification of the PAP sensitive assets protected in integrity;**
 - PAP Selection failure;**
 - PAP Activation failure;**
 - PAP Services failure**
- known to indicate a potential security violation;
- b) **No other rules.**

FAU_GEN.1 Audit data generation

FAU_GEN.1.1 The TSF shall be able to generate an audit record of the following auditable events:

- a) Start-up and shutdown of the audit functions;
- b) All auditable events for the **not specified** level of audit; and
- c) **The following auditable events:**
 - Payment transactions;**

Application Note: c) the Payment transactions auditable events are given in FAU_SAA.1.2.

FAU_GEN.1.2 The TSF shall record within each audit record at least the following information:

- a) Date and time of the event, type of event, subject identity (if applicable), and the outcome (success or failure) of the event; and
- b) For each audit event type, based on the auditable event definitions of the functional components included in the PP/ST.

	Reference D1270292	Release 1.01p <small>(Printed copy not controlled: verify the version before using)</small>
	Classification level Public	Pages 133

Application Note: In the context of Payment transactions,

- Date/time is logged only for accepted/rejected transaction. For online transaction, date/time will not record.
- The only type of event is payment transaction.
- The records are given in FAU_SAR.1/CUSTOMER and FAU_SAR.1/ISSUING_BANK

FAU_SAR.1/CUSTOMER Audit review

FAU_SAR.1.1/CUSTOMER The TSF shall provide **U.CUSTOMER** with the capability to read the following audit information:

- Purchase Amount;**
- Purchase Currency;**
- Transaction Date;**
- Cryptogram Information Data;**
- Application Transaction Counter;**
- Card Verification Results**

from the audit records.

FAU_SAR.1.2/CUSTOMER The TSF shall provide the audit records in a manner suitable for the user to interpret the information.

FAU_SAR.1/ISSUING_BANK Audit review

FAU_SAR.1.1/ISSUING_BANK The TSF shall provide **U.ISSUING_BANK** with the capability to read all available information from the audit records.

FAU_SAR.1.2/ISSUING_BANK The TSF shall provide the audit records in a manner suitable for the user to interpret the information.

6.1.5 CRYPTOGRAPHIC SUPPORT

FCS_CKM.1/Session Keys Cryptographic key generation

FCS_CKM.1.1/Session Keys The TSF shall generate cryptographic keys in accordance with a specified cryptographic key generation algorithm **PAP Session Keys Derivation** and specified cryptographic key sizes **16 bytes** that meet the following: **[PM-1] and [PM-2] standard**.

FCS_CKM.4/Session Keys Cryptographic key destruction

FCS_CKM.4.1/Session Keys The TSF shall destroy cryptographic keys in accordance with a specified cryptographic key destruction method (**clearKey() method**) that meet the following: **[JCAPI222]**.

Application Note:

- Same SFR than platform one.

	Reference	D1270292	Release	1.01p <small>(Printed copy not controlled: verify the version before using)</small>
	Classification level	Public	Pages	133

FCS_COP.1/Offline Data Authentication Cryptographic operation

FCS_COP.1.1/Offline Data Authentication The TSF shall perform **Signature operation** in accordance with a specified cryptographic algorithm **RSA** and cryptographic key sizes **176 bytes** that meet the following: **[PM-1]** and **[PM-2]** specification.

FCS_COP.1/Application Cryptogram Cryptographic operation

FCS_COP.1.1/Application Cryptogram The TSF shall perform **MAC CBC cryptogram generation** in accordance with a specified cryptographic algorithm **3DES** and cryptographic key sizes **16 bytes** that meet the following: **[PM-1]** and **[PM-2]** specifications.

FCS_COP.1/Script Processing Cryptographic operation

FCS_COP.1.1/Script Processing The TSF shall perform **Cryptogram generation** in accordance with a specified cryptographic algorithm **3DES** and cryptographic key sizes **16 bytes** that meet the following: **[PM-1]** and **[PM-2]** specifications.

FCS_COP.1/Messages Data Integrity Cryptographic operation

FCS_COP.1.1/Messages Data Integrity The TSF shall perform **MAC Computation** in accordance with a specified cryptographic algorithm **3DES** and cryptographic key sizes **16 bytes** that meet the following: **[PM-1]** and **[PM-2]** specifications.

FCS_COP.1/Messages Data Confidentiality Cryptographic operation

FCS_COP.1.1/Messages Data Confidentiality The TSF shall perform **Encipherment** in accordance with a specified cryptographic algorithm **3DES** and cryptographic key sizes **16 bytes** that meet the following: **[PM-1]** and **[PM-2]** specifications.

	Reference	D1270292	Release	1.01p <small>(Printed copy not controlled: verify the version before using)</small>
	Classification level	Public	Pages	133

6.1.6 PROTECTION

FDP_SDI.2 Stored data integrity monitoring and action

FDP_SDI.2.1 The TSF shall monitor user data stored in containers controlled by the TSF for **corruption** on all objects, based on the following attributes:

- all stored Transaction management data;**
- all stored Temporary data during transaction processing integrity;**
- all stored Temporary data during Post-Issuance Bank Management.**

FDP_SDI.2.2 Upon detection of a data integrity error, the TSF shall

- deactivate and lock the PAP;**
- or Mute the (U)SIM card;**
- or Clear secret data;**

FPT_TST.1 TSF testing

FPT_TST.1.1 The TSF shall run a suite of self tests **at the conditions: before PAP application usage** to demonstrate the correct operation of: **PAP application**.

FPT_TST.1.2 The TSF shall provide authorised users with the capability to verify the integrity of: **Transaction Management Data (TSF persistent data)**.

FPT_TST.1.3 The TSF shall provide authorised users with the capability to verify the integrity of: **PAP application code**.

Application Note:

- This is not TSF's self-tests but points are covered by SFRs of the platform to verify the integrity of persistent data and to verify the integrity of PAP application code during loading, and then covered by the composition with the platform.
- This **FPT_TST.1** is not useful to cover the security objectives of this document because already covered by FDP SFRs, but written here according to [PAP].

FPT_RPL.1 Replay detection

FPT_RPL.1.1 The TSF shall detect replay for the following entities: **Issuer Scripts and VERIFY commands** .

FPT_RPL.1.2 The TSF shall perform **reject the replay and increase counter** when replay is detected.

Application Note:

- **if attack replay Issuer Scripts like PIN CHANGE UNBLOCK / APPLICATION UNBLOCK / UPDATE RECORD etc, the replay will be rejected and SMI counter will be increased**
- **if attack replay VERIFY (PIN) Enciphered command which he sniffed from line, the replay will be rejected and Bad Crypto Counter will be increased**

	Reference	D1270292	Release	1.01p <small>(Printed copy not controlled: verify the version before using)</small>
	Classification level	Public	Pages	133

FDP_RIP.1 Subset residual information protection

FDP_RIP.1.1 The TSF shall ensure that any previous information content of a resource is made unavailable upon the **deallocation of the resource from** the following objects:

- PAP Reference Personal Code;**
- PAP Personal Code;**
- PAP Keys.**

Application Note:

- The PAP Reference Personal Code is created during personalization and cleared during reset personalization

6.1.7 MANAGEMENT

FMT_SMF.1/ Functionalities Specification of Management Functions

FMT_SMF.1.1/ Functionalities The TSF shall be capable of performing the following management functions:

- Post-Issuance Bank Management (issuing-bank scripts);**
- Communication channels selection;**
- OTA Issuance Management (TSM can install the MPP instance over the air and personalize the installed instance over the air too);***
- Customer personal parameter setup (Customer can setup some personal parameters in MPP via MIDlet).***

Application Note:

- The communication channels selection is to be considered as a way to identify the origin by determining the contact or contactless protocol.

FMT_MOF.1/ Parameters Management of security functions behaviour

FMT_MOF.1.1/ Parameters The TSF shall restrict the ability to **disable, enable and modify the behaviour of** the functions

- PAP Selection;**
 - PAP Activation/Deactivation;**
 - PAP Offline Data Authentication;**
 - PAP Offline Transaction;**
 - PAP Online Transaction;**
 - Personal Code Verification**
- to the Issuing Bank.

	Reference	D1270292	Release	1.01p <small>(Printed copy not controlled: verify the version before using)</small>
	Classification level	Public	Pages	133

FMT_MTD.1/ Secrets Management of TSF data

FMT_MTD.1.1/ Secrets The TSF shall restrict the ability to **modify** the **PAP TSF data (all)** to the Issuing Bank.

FMT_MSA.1/ Issuing Bank Management of security attributes

FMT_MSA.1.1/ Issuing Bank The TSF shall enforce the **Post-Issuance Bank Management Access Control SFP and Post-Issuance Bank Management Information Control SFP** to restrict the ability to **modify** the security attributes **all the PAP security attributes** to the Issuing Bank.

FMT_MSA.2 Secure security attributes

FMT_MSA.2.1 The TSF shall ensure that only secure values are accepted for **security attributes defined in PAP Transaction Access Control SFP and PAP Offline Transaction, PAP Online Transaction Information Control SFP.**

FMT_MSA.3 Static attribute initialisation

FMT_MSA.3.1 The TSF shall enforce the **following SFP** to provide **restrictive** default values for security attributes that are used to enforce the SFP.

SFPs are:

- **Post-Issuance Bank Management Access Control SFP/ Information Control SFP**
- **PAP Application Access Control SFP**
- **PAP Activation Access Control SFP**
- **PAP Administration Management Access Control SFP**
- **PAP Payment Transaction Management Access Control SFP**
- **PAP Offline Authentication Access Control SFP/Information Control SFP**
- **PAP Transaction Access Control SFP**
- **PAP Offline Transaction Information Control SFP**
- **PAP Online Transaction Information Control SFP**

FMT_MSA.3.2 The TSF shall allow the **Issuing Bank and MNO** to specify alternative initial values to override the default values when an object or information is created.

FMT_SMR.1 Security roles

FMT_SMR.1.1 The TSF shall maintain the roles

Customer;
Issuing Bank;
MNO.

FMT_SMR.1.2 The TSF shall be able to associate users with roles.

	Reference	D1270292	Release	1.01p <small>(Printed copy not controlled: verify the version before using)</small>
	Classification level	Public	Pages	133

6.1.8 IDENTIFICATION / AUTHENTICATION

FIA_AFL.1/ Customer Authentication failure handling

FIA_AFL.1.1/ Customer The TSF shall detect when **Personal Code Try Counter Limit** unsuccessful authentication attempts occur related to **the Personal Code Verification**.

FIA_AFL.1.2/ Customer When the defined number of unsuccessful authentication attempts has been **surpassed**, the TSF shall
return an error, as specified in [PM-1] and [PM-2];
block the PAP Reference Personal Code until the Issuing Bank unblocks it.

Application Note:

- The Personal Code Try Counter Limit is created during personalization

FIA_AFL.1/ Issuing Bank Authentication failure handling

FIA_AFL.1.1/ Issuing Bank The TSF shall detect when **an administrator configurable positive integer within range of acceptable values** unsuccessful authentication attempts occur related to **Issuing Bank Authentication**.

FIA_AFL.1.2/ Issuing Bank When the defined number of unsuccessful authentication attempts has been **surpassed**, the TSF shall
return an error as specified in [GP-4].

Application Note: The range of values is 1~FFFFh.

FIA_ATD.1 User attribute definition

FIA_ATD.1.1 The TSF shall maintain the following list of security attributes belonging to individual users:

- Personal Code Verification Security Attributes (PAP Transaction Parameters);**
- Issuing Bank Authentication Security Attributes (PAP Transaction Parameters).**

FIA_UAU.1/ PAP Online Transaction Timing of authentication

FIA_UAU.1.1/ PAP Online Transaction The TSF shall allow
PAP Action analysis;
establishment of a trusted path dedicated to the current payment transaction
on behalf of the user to be performed before the user is authenticated.

	Reference	D1270292	Release	1.01p <small>(Printed copy not controlled: verify the version before using)</small>
	Classification level	Public	Pages	133

Refinement: "User authentication" stands for the authentication using the Personal Code of the PAP.

FIA_UAU.1.2/ PAP Online Transaction The TSF shall require each user to be successfully authenticated before allowing any other TSF-mediated actions on behalf of that user.

FIA_UAU.1/ Post-Issuance Bank Management Timing of authentication

FIA_UAU.1.1/ Post-Issuance Bank Management The TSF shall allow
selecting a PAP on the (U)SIM card;
requesting data that identifies the Issuing Bank;
establishment of a trusted path dedicated to the Post-Issuance Bank Management
on behalf of the user to be performed before the user is authenticated.

Refinement: "User authentication" stands for the authentication using the Personal Code.

FIA_UAU.1.2/ Post-Issuance Bank Management The TSF shall require each user to be successfully authenticated before allowing any other TSF-mediated actions on behalf of that user.

FIA_UAU.1/ Payment Transaction Timing of authentication

FIA_UAU.1.1/ Payment Transaction The TSF shall allow **all operations except payment transactions** on behalf of the user to be performed before the user is authenticated.

Refinement: "User authentication" stands for the authentication of the user to the (U)SIM card by mean of the PAP PIN code.

FIA_UAU.1.2/ Payment Transaction The TSF shall require each user to be successfully authenticated before allowing any other TSF-mediated actions on behalf of that user.

Application Note: This authentication shall be handled by the (U)SIM platform. The PAP shall be able to verify the state of the customer authentication by the (U)SIM platform.

FIA_UAU.3 Unforgeable authentication

FIA_UAU.3.1 The TSF shall **detect** use of authentication data that has been forged by any user of the TSF.

FIA_UAU.3.2 The TSF shall **detect** use of authentication data that has been copied from any other user of the TSF.

FIA_UAU.4 Single-use authentication mechanisms

FIA_UAU.4.1 The TSF shall prevent reuse of authentication data related to
PAP Offline Data Authentication;
PAP Issuing Bank and MNO Authentication.

	Reference D1270292	Release 1.01p <small>(Printed copy not controlled: verify the version before using)</small>
	Classification level Public	Pages 133

FIA_UAU.6/ Customer Re-authenticating

FIA_UAU.6.1/ Customer The TSF shall re-authenticate the user under the conditions:

- Pre-enter PIN not allowed by issuer (depends on issuer configuration)
- Transaction Context conflict
- After completion of one payment transaction (depends on issuer configuration and card holder option)
- After card reset
- Upon reception of SET-RESET-PARAMETERS with P1P2=Reset CVM

FIA_UID.1/ PAP Online Transaction Timing of identification

FIA_UID.1.1/ PAP Online Transaction The TSF shall allow **all TSF-mediated actions listed in FIA_UAU.1/PAP Online Transaction** on behalf of the user to be performed before the user is identified.

FIA_UID.1.2/ PAP Online Transaction The TSF shall require each user to be successfully identified before allowing any other TSF-mediated actions on behalf of that user.

FIA_UID.1/ Post-Issuance Bank Management Timing of identification

FIA_UID.1.1/ Post-Issuance Bank Management The TSF shall allow **all TSF-mediated actions listed in FIA_UAU.1/ Post-Issuance Bank Management** on behalf of the user to be performed before the user is identified.

FIA_UID.1.2/ Post-Issuance Bank Management The TSF shall require each user to be successfully identified before allowing any other TSF-mediated actions on behalf of that user.

FIA_UID.1/ Payment Transaction Timing of identification

FIA_UID.1.1/ Payment Transaction The TSF shall allow **all TSF-mediated actions listed in FIA_UAU.1/ Payment Transaction** on behalf of the user to be performed before the user is identified.

FIA_UID.1.2/ Payment Transaction The TSF shall require each user to be successfully identified before allowing any other TSF-mediated actions on behalf of that user.

	Reference	D1270292	Release	1.01p <small>(Printed copy not controlled: verify the version before using)</small>
	Classification level	Public	Pages	133

FIA_USB.1 User-subject binding

FIA_USB.1.1 The TSF shall associate the following user security attributes with subjects acting on the behalf of that user:

PAP Transaction Parameters State.

FIA_USB.1.2 The TSF shall enforce the following rules on the initial association of user security attributes with subjects acting on the behalf of users:

PAP Transaction Parameters State initially indicates no identification/authentication of the user.

FIA_USB.1.3 The TSF shall enforce the following rules governing changes to the user security attributes associated with subjects acting on the behalf of users: **none**.

FIA_SOS.2 TSF Generation of secrets

FIA_SOS.2.1 The TSF shall provide a mechanism to generate secrets that meet **the STANDARD level as specified in platform (refer to [DCSSI2741])**.

FIA_SOS.2.2 The TSF shall be able to enforce the use of TSF generated secrets for **the generation of the 8-bytes challenge used for cryptographic operations**.

Refinement: "secrets" stand for random values.

Application Note: The 8-bytes challenge is generated from Applicative Get Challenge from Platform Javacard API `javacard.security.RandomData.generateData`.

FDP_DAU.1 Basic Data Authentication

FDP_DAU.1.1 The TSF shall provide a capability to generate evidence that can be used as a guarantee of the validity of **the following objects and information**:

Contactless Life Cycle;
(U)SIM Life Cycle Status;
PAP Code;
PAP Selection and Activation Parameters;
PAP Transaction Parameters;
PAP Keys;
Reference Personal Code;
PAP Log File;
PAP Counters;
PAP Customer Account Information.

FDP_DAU.1.2 The TSF shall provide **S.PAP** with the ability to verify evidence of the validity of the indicated information.

*Application Note: This **FDP_DAU.1** is not appropriate but written here according to [PAP]. This SFR has to be used as integrity control.*

	Reference	D1270292	Release	1.01p <small>(Printed copy not controlled: verify the version before using)</small>
	Classification level	Public	Pages	133

6.1.9 ACCESS and INFORMATION FLOW CONTROL SFP

FDP_ITC.2/ Post-Issuance Bank Management Import of user data with security attributes

FDP_ITC.2.1/ Post-Issuance Bank Management The TSF shall enforce the **Post-Issuance Bank Management Access Control and the Post-Issuance Bank Management Information Flow Control SFPs** when importing user data, controlled under the SFP, from outside of the TOE.

FDP_ITC.2.2/ Post-Issuance Bank Management The TSF shall use the security attributes associated with the imported user data.

FDP_ITC.2.3/ Post-Issuance Bank Management The TSF shall ensure that the protocol used provides for the unambiguous association between the security attributes and the user data received.

FDP_ITC.2.4/ Post-Issuance Bank Management The TSF shall ensure that interpretation of the security attributes of the imported user data is as intended by the source of the user data.

FDP_ITC.2.5/ Post-Issuance Bank Management The TSF shall enforce the following rules when importing user data controlled under the SFP from outside the TOE:

the Issuing Bank Transaction Parameters are verified in origin and integrity (and confidentiality if required) following [PM-1] and [PM-2] specifications.

FDP_ITC.2/ PAP Transaction Import of user data with security attributes

FDP_ITC.2.1/ PAP Transaction The TSF shall enforce the **PAP Transaction Access Control and the PAP Online Transaction Information Flow Control SFPs** when importing user data, controlled under the SFP, from outside of the TOE.

FDP_ITC.2.2/ PAP Transaction The TSF shall use the security attributes associated with the imported user data.

FDP_ITC.2.3/ PAP Transaction The TSF shall ensure that the protocol used provides for the unambiguous association between the security attributes and the user data received.

FDP_ITC.2.4/ PAP Transaction The TSF shall ensure that interpretation of the security attributes of the imported user data is as intended by the source of the user data.

FDP_ITC.2.5/ PAP Transaction The TSF shall enforce the following rules when importing user data controlled under the SFP from outside the TOE:

the Issuing Bank Transaction Data are verified in origin and integrity (and confidentiality if required) following [PM-1] and [PM-2] specifications.

	Reference	D1270292	Release	1.01p <small>(Printed copy not controlled: verify the version before using)</small>
	Classification level	Public	Pages	133

FDP_ETC.1 Export of user data without security attributes

FDP_ETC.1.1 The TSF shall enforce the **TOE's Access Control and Information Flow Control SFPs (all)** when exporting user data, controlled under the SFP(s), outside of the TOE.

FDP_ETC.1.2 The TSF shall export the user data without the user data's associated security attributes

FDP_ITC.1 Import of user data without security attributes

FDP_ITC.1.1 The TSF shall enforce the **Access Control and Information Flow Control SFPs (all except those enforced in FDP_ITC.2/ Post-Issuance Bank Management and FDP_ITC.2/ PAP Transaction)** when importing user data, controlled under the SFP, from outside of the TOE.

FDP_ITC.1.2 The TSF shall ignore any security attributes associated with the user data when imported from outside the TOE.

FDP_ITC.1.3 The TSF shall enforce the following rules when importing user data controlled under the SFP from outside the TOE: **None**.

FDP_UIT.1 Data exchange integrity

FDP_UIT.1.1 The TSF shall enforce the **PAP Offline Transaction, PAP Online Transaction and the Post-Issuance Bank Management Information Flow Control SFPs** to receive user data in a manner protected from **replay, insertion, deletion and modification** errors.

FDP_UIT.1.2 The TSF shall be able to determine on receipt of user data, whether **modification, deletion, insertion and replay** has occurred.

6.1.10 SECURE CHANNEL

FPT_TDC.1 Inter-TSF basic TSF data consistency

FPT_TDC.1.1 The TSF shall provide the capability to consistently interpret **the following TSF data types** when shared between the TSF and another trusted IT product.

The TSF data types are:

- **PAP Reference Personal Code State**
- **PAP Counters Integrity and PAP Counters State**
- **Contactless Life Cycle State**
- **PAP Transaction processing State and Issuing Bank Transaction Data Confidentiality (if required), Integrity and Origin**

FPT_TDC.1.2 The TSF shall use **the rules defined in [PM-1]&[PM-2]** when interpreting the TSF data from another trusted IT product.

	Reference	D1270292	Release	1.01p <small>(Printed copy not controlled: verify the version before using)</small>
	Classification level	Public	Pages	133

FTP_ITC.1 Inter-TSF trusted channel

FTP_ITC.1.1 The TSF shall provide a communication channel between itself and another trusted IT product that is logically distinct from other communication channels and provides assured identification of its end points and protection of the channel data from modification or disclosure.

FTP_ITC.1.2 The TSF shall permit **another trusted IT product** to initiate communication via the trusted channel.

FTP_ITC.1.3 The TSF shall initiate communication via the trusted channel for
PAP Online Transaction;
Post-Issuance Bank Management.

6.1.11 UNOBSERVABILITY

FPR_UNO.1 Unobservability

FPR_UNO.1.1 The TSF shall ensure that **all users and subjects** are unable to observe the operation **PIN comparison and key comparison on the Reference Personal Code and the PAP keys performed by S.PAP.**

6.2 Security Assurance Requirements

The Evaluation Assurance Level is EAL4 augmented with ALC_DVS.2 and AVA_VAN.5.

	Reference	D1270292	Release	1.01p <small>(Printed copy not controlled: verify the version before using)</small>
	Classification level	Public	Pages	133

6.3 Security Requirements Rationale

6.3.1 Objectives

6.3.1.1 Security Objectives for the TOE

TRANSACTION PROTECTION

O.TRANSACTION_UNIQUENESS This security objective is met by the following SFRs:

FCS_COP.1/Application Cryptogram,FCS_CKM.1/Session Keys, FCS_CKM.4/Session keys which guarantees that transaction cryptograms are generated in accordance with the [PM-1]&[PM-2] specifications.

All access and information flow control SFPs (FDP_ACC.2/ PAP Application, FDP_ACF.1/ PAP Application, FDP_IFC.2/ PAP Offline Authentication, FDP_IFF.1/ PAP Offline Authentication, FDP_ACC.2/ PAP Activation, FDP_ACF.1/ PAP Activation, FDP_ACF.1/ PAP Administration Management, FDP_ACF.1/ PAP Payment Transaction Management, FDP_ACF.1/ PAP Offline Authentication, FDP_ACF.1/ Post-Issuance Bank Management, FDP_ACF.1/ PAP Transaction, FDP_IFC.2/ PAP Offline Transaction, FDP_IFC.2/ PAP Online Transaction, FDP_IFC.2/ Post-Issuance Bank Management, FDP_IFF.1/ PAP Offline Transaction, FDP_IFF.1/ PAP Online Transaction, FDP_IFF.1/ Post-Issuance Bank Management, FDP_ACC.2/ PAP Administration Management, FDP_ACC.2/ PAP Payment Transaction Management, FDP_ACC.2/ Post-Issuance Bank Management, FDP_ACC.2/ PAP Offline Authentication, FDP_ACC.2/ PAP Transaction, FDP_ETC.1 and FDP_ITC.1) are enforced for cryptogram generation and thus help in preserving the uniqueness of a transaction.

FDP_UIT.1 which guarantees the integrity of data exchanged from and to the TOE by detecting unauthorised modification and replayed transactions.

O.TRANSACTION_INTEGRITY This security objective is met by the following SFRs:

All access and information flow control SFPs (FDP_ACC.2/ PAP Application, FDP_ACF.1/ PAP Application, FDP_IFC.2/ PAP Offline Authentication, FDP_IFF.1/ PAP Offline Authentication, FDP_ACC.2/ PAP Activation, FDP_ACF.1/ PAP Activation, FDP_ACF.1/ PAP Administration Management, FDP_ACF.1/ PAP Payment Transaction Management, FDP_ACF.1/ PAP Offline Authentication, FDP_ACF.1/ Post-Issuance Bank Management, FDP_ACF.1/ PAP Transaction, FDP_IFC.2/ PAP Offline Transaction, FDP_IFC.2/ PAP Online Transaction, FDP_IFC.2/ Post-Issuance Bank Management, FDP_IFF.1/ PAP Offline Transaction, FDP_IFF.1/ PAP Online Transaction, FDP_IFF.1/ Post-Issuance Bank Management, FDP_ACC.2/ PAP Administration Management, FDP_ACC.2/ PAP Payment Transaction Management, FDP_ACC.2/ Post-Issuance Bank Management, FDP_ACC.2/ PAP Offline Authentication, FDP_ACC.2/ PAP Transaction, FDP_ETC.1, FDP_ITC.1, FDP_ITC.2/ PAP Transaction FDP_ITC.2/ Post-Issuance Bank Management), FPT_TDC.1 and FDP_UIT.1 are enforced for transactions and thus help in preserving the integrity of a transaction.

The SFRs FMT_MOF.1/ Parameters, FMT_MSA.1/ Issuing Bank and FMT_MSA.3 contributes in covering this security objective by restricting the modification of parameters to the Issuing Bank.

O.TRANSACTION_BYPASS This security objective is satisfied by the following SFRs:

All access and information flow control SFPs (FDP_ACC.2/ PAP Application, FDP_ACF.1/ PAP Application, FDP_IFC.2/ PAP Offline Authentication, FDP_IFF.1/ PAP Offline Authentication, FDP_ACC.2/ PAP Activation, FDP_ACF.1/ PAP Activation, FDP_ACF.1/ PAP Administration Management, FDP_ACF.1/ PAP Payment Transaction Management, FDP_ACF.1/ PAP Offline Authentication, FDP_ACF.1/ PAP Offline Authentication, FDP_ACF.1/ Post-Issuance Bank Management, FDP_ACF.1/ PAP Transaction,

	Reference D1270292	Release 1.01p <small>(Printed copy not controlled: verify the version before using)</small>
	Classification level Public	Pages 133

FDP_IFC.2/ PAP Offline Transaction, FDP_IFC.2/ PAP Online Transaction, FDP_IFC.2/ Post-Issuance Bank Management, FDP_IFF.1/ PAP Offline Transaction, FDP_IFF.1/ PAP Online Transaction, FDP_IFF.1/ Post-Issuance Bank Management, FDP_ACC.2/ PAP Administration Management, FDP_ACC.2/ PAP Payment Transaction Management, FDP_ACC.2/ Post-Issuance Bank Management, FDP_ACC.2/ PAP Offline Authentication, FDP_ACC.2/ PAP Transaction, FDP_ETC.1, FDP_ITC.1, FDP_ITC.2/ PAP Transaction and FDP_ITC.2/ Post-Issuance Bank Management) and FPT_TDC.1 are enforced for transaction process and thus help in ensuring a non-bypassability of the transaction flow model.

FIA_UAU.1/ PAP Online Transaction, FIA_UAU.1/ Post-Issuance Bank Management, FIA_UAU.1/ Payment Transaction, FIA_UID.1/ PAP Online Transaction, FIA_UID.1/ Payment Transaction, FIA_UID.1/ Post-Issuance Bank Management, FIA_AFL.1/ Customer, FIA_AFL.1/ Issuing Bank which enforce users identification and authentication to perform some actions as defined in the [PM-1]&[PM-2] specifications.

The PAP Online Transaction in Payment mode does'nt need Issuing-Bank authentication: the online approval is handled by POS terminal.

The PAP Online Transaction in Managment mode (Counter Reset, Issuer Script) needs Issuing-Bank authentication.

	Reference D1270292	Release 1.01p <small>(Printed copy not controlled: verify the version before using)</small>
	Classification level Public	Pages 133

O.TRANSACTION_REPLAY This security objective is covered by the following SFRs:

- FPT_RPL.1/ which ensures that all transactions are protected against replay; the TSF can detect it and react to such attack.
- FIA_SOS.2/ which ensures the TOE can generate random value to enforce the protection against replay attacks.
- FIA_UAU.4 guarantees that authentication data cannot be reused.
- FCS_CKM.1/Session Keys and FCS_CKM.4/Session keys ensures that session keys generation and destruction meet the requirements of [PM-1]&[PM-2]
- FDP_UIT.1 which guarantees the integrity of data exchanged from and to the TOE by detecting replayed transactions.

AUTHENTICATION

O.USER_AUTH This objective is covered by:

- FIA_UAU.1/ PAP Online Transaction which require the authentication of the customer to the TOE to perform a transaction,
- FIA_UAU.3 which prevents against use of forged authentication data,
- FIA_UAU.4 which prevents against reuse of authentication data,
- FIA_UAU.6/ Customer that requests customer re-authentication when it is required
- FIA_SOS.2 which ensures the TOE can generate random value to perform authentication processes.
- FIA_ATD.1 guarantees that security attributes belonging to customer are securely maintained.
- FDP_ACC.2/ PAP Application, FDP_ACF.1/ PAP Application, FDP_ACF.1/ PAP Administration Management, FDP_ACF.1/ PAP Payment Transaction Management, FDP_ACC.2/ PAP Administration Management, FDP_ACC.2/ PAP Payment Transaction Management that define access controls for the Customer
- FMT_SMR.1 that associates the roles to the Customer
- FDP_RIP.1 and FIA_AFL.1/ Customer that provide protection against brute force attacks and cryptographic extraction of residual information on the Personal Code.
- FCS_COP.1/Messages Data Integrity, FCS_COP.1/Messages Data Confidentiality which ensure cryptographic support for authentication mechanisms
- FIA_USB.1 ensures that the appropriate security attributes are associated to the Customer authentication

O.ISSUING_BANK_AUTH This objective is covered by:

- FIA_UAU.1/ Post-Issuance Bank Management which require a successful authentication of the Issuing Bank to the TOE to perform a transaction,
- FIA_UAU.3 which prevents against use of forged authentication data,
- FIA_UAU.4 which prevents against reuse of authentication data,
- FIA_SOS.2 which ensures the TOE can generate random value to perform authentication processes.
- FIA_AFL.1/ Issuing Bank that detects unauthorised authentications events
- FIA_ATD.1 guarantees that security attributes belonging to the Issuing Bank are securely maintained.
- FIA_USB.1 ensures that the appropriate security attributes are associated to the Issuing Bank authentication
- FDP_ACC.2/ Post-Issuance Bank Management, FDP_ACF.1/ Post-Issuance Bank Management, FDP_ACC.2/ PAP Application, FDP_ACF.1/ PAP Application, FDP_ACF.1/ PAP Administration Management, FDP_ACF.1/ PAP Payment Transaction Management,

	Reference D1270292	Release 1.01p <small>(Printed copy not controlled: verify the version before using)</small>
	Classification level Public	Pages 133

FDP_ACC.2/ PAP Administration Management, FDP_ACC.2/ PAP Activation, FDP_ACC.2/ PAP Payment Transaction Management, FDP_ACF.1/ PAP Activation that define access controls to the TOE for the Issuing Bank

FDP_ETC.1, FDP_ITC.1 and FDP_ITC.2/ Post-Issuance Bank Management and FPT_TDC.1 ensure that security attributes are not exported and those related to Post-Issuance Bank Management are covered.

FMT_SMR.1 that associates the roles to the Issuing Bank

FCS_COP.1/Messages Data Integrity, FCS_COP.1/Messages Data Confidentiality, FCS_COP.1/Script Processing which ensure cryptographic support for authentication mechanisms

EXECUTION PROTECTION

O.AUTHORISATION CONTROL This security objective is covered by the following SFRs:

Access and information flow control SFPs (FDP_ACC.2/ PAP Application, FDP_ACF.1/ PAP Application, FDP_ACC.2/ PAP Activation, FDP_ACF.1/ PAP Activation, FDP_ACF.1/ PAP Administration Management, FDP_ACF.1/ PAP Payment Transaction Management, FDP_ACF.1/ PAP Transaction, FDP_IFC.2/ PAP Online Transaction, FDP_IFF.1/ PAP Online Transaction, FDP_ACC.2/ PAP Administration Management, FDP_ACC.2/ PAP Payment Transaction Management, FDP_ACC.2/ PAP Transaction and FDP_ITC.1) are enforced for authorisation requests and thus help in preserving the consistency of payment transactions.

FIA_UAU.1/ PAP Online Transaction which enforces users successful authentication to perform payment transactions as defined in the [PM-1]&[PM-2] specifications

DATA PROTECTION

O.DATA DISCLOSURE This security objective is satisfied by the following SFRs:

FDP_RIP.1 that prevent residual information on the Personal Code and the PAP keys

All access and information flow control SFPs (FDP_ACC.2/ PAP Application, FDP_ACF.1/ PAP Application, FDP_IFC.2/ PAP Offline Authentication, FDP_IFF.1/ PAP Offline Authentication, FDP_ACC.2/ PAP Activation, FDP_ACF.1/ PAP Activation, FDP_ACF.1/ PAP Administration Management, FDP_ACF.1/ PAP Payment Transaction Management, FDP_ACF.1/ PAP Offline Authentication, FDP_ACF.1/ PAP Offline Authentication, FDP_ACF.1/ Post-Issuance Bank Management, FDP_ACF.1/ PAP Transaction, FDP_IFC.2/ PAP Offline Transaction, FDP_IFC.2/ PAP Online Transaction, FDP_IFC.2/ Post-Issuance Bank Management, FDP_IFF.1/ PAP Offline Transaction, FDP_IFF.1/ PAP Online Transaction, FDP_IFF.1/ Post-Issuance Bank Management, FDP_ACC.2/ PAP Administration Management, FDP_ACC.2/ PAP Payment Transaction Management, FDP_ACC.2/ Post-Issuance Bank Management, FDP_ACC.2/ PAP Offline Authentication, FDP_ACC.2/ PAP Transaction) helps in ensuring the confidentiality of the User data

FDP_ETC.1, FDP_ITC.1, FDP_ITC.2/ Post-Issuance Bank Management, FDP_ITC.2/ PAP Transaction and FPT_TDC.1 that cover the confidentiality of user data when imported and exported.

FAU_ARP.1 that prevents and react from potential security violation

FAU_SAA.1 - FAU_SAA.1 which specifies rules that preserve the confidentiality of log files.

FCS_COP.1/Offline Data Authentication, FCS_COP.1/Script Processing and FCS_COP.1/Messages Data Confidentiality that specify cryptographic algorithms that shall be used to ensure the confidentiality of transmitted data. -FPR_UNO.1 which specifies that PIN comparison and Key comparison are unobservable.

	Reference D1270292	Release 1.01p <small>(Printed copy not controlled: verify the version before using)</small>
	Classification level Public	Pages 133

O.DATA_INTEGRITY This security objective is satisfied by the following SFRs:

All access and information flow control SFPs (FDP_ACC.2/ PAP Application, FDP_ACF.1/ PAP Application, FDP_IFC.2/ PAP Offline Authentication, FDP_IFF.1/ PAP Offline Authentication, FDP_ACC.2/ PAP Activation, FDP_ACF.1/ PAP Activation, FDP_ACF.1/ PAP Administration Management, FDP_ACF.1/ PAP Payment Transaction Management, FDP_ACF.1/ PAP Offline Authentication, FDP_ACF.1/ PAP Offline Authentication, FDP_ACF.1/ Post-Issuance Bank Management, FDP_ACF.1/ PAP Transaction, FDP_IFC.2/ PAP Offline Transaction, FDP_IFC.2/ PAP Online Transaction, FDP_IFC.2/ Post-Issuance Bank Management, FDP_IFF.1/ PAP Offline Transaction, FDP_IFF.1/ PAP Online Transaction, FDP_IFF.1/ Post-Issuance Bank Management, FDP_ACC.2/ PAP Administration Management, FDP_ACC.2/ PAP Payment Transaction Management, FDP_ACC.2/ Post-Issuance Bank Management, FDP_ACC.2/ PAP Offline Authentication, FDP_ACC.2/ PAP Transaction) helps in ensuring the integrity of the User data

FDP_ETC.1, FDP_ITC.1, FDP_ITC.2/ Post-Issuance Bank Management, FDP_ITC.2/ PAP Transaction and FPT_TDC.1 that cover the integrity of user data when imported and exported.

FAU_ARP.1 that prevents and react from potential security violation

FAU_SAA.1 which specifies rules that preserve the integrity of log files.

FCS_COP.1/Offline Data Authentication, FCS_COP.1/Script Processing, FCS_COP.1/Application Cryptogram and FCS_COP.1/Messages Data Integrity that specify cryptographic algorithms that shall be used to ensure the integrity of transmitted data.

FDP_DAU.1 that guarantees the validity of objects and information

FDP_SDI.2 which ensure that data integrity is controlled by the TSF

FDP_UIT.1 which guarantees the integrity of data exchanged from and to the TOE by detecting unauthorised modification of data.

FTP_ITC.1 that requires a communication channel that guarantees the integrity of transmitted data

FMT_MSA.1/ Issuing Bank and FMT_MSA.3 that protect the security attributes

FMT_MOF.1/ Parameters and FMT_MTD.1/ Secrets that restrict the ability to modify TSF data and security functions to the Issuing Bank and thus protect their integrity.

FPT_TST.1 covered by the Platform according to composition (refer to application note of the SFR).

O.DATA_USERS This security objective is covered by the following SFR:

FMT_SMR.1 which ensures that users are associated with roles and these roles are maintained by the TSF.

FIA_UAU.1/ PAP Online Transaction, FIA_UAU.1/ Payment Transaction, FIA_UAU.1/ Post-Issuance Bank Management, as well as FIA_AFL.1.1/ Customer and FIA_AFL.1.1/ Issuing Bank which ensures the Customer and Issuing Bank authentication. Note that the MNO authentication is ensured by the Platform according to composition.

	Reference D1270292	Release 1.01p <small>(Printed copy not controlled: verify the version before using)</small>
	Classification level Public	Pages 133

RISK MANAGEMENT

O.RISK_MNGT This security objective is met by the following SFRs:

FDP_ACC.2/ PAP Transaction and FDP_ACF.1/ PAP Transaction, FDP_IFC.2/ PAP Offline Transaction and FDP_IFF.1/ PAP Offline Transaction, and FDP_IFC.2/ PAP Online Transaction and FDP_IFF.1/ PAP Online Transaction, which ensure number of transactions without authorization does not exceed maximum values of risk management counters.

FDP_UIT.1 which ensures that data are protected during transmission from and to the TOE. Unauthorised modification and replay attacks are detected.

FMT_MSA.2 which guarantees that only secure values are accepted for security attributes

O.APP_BLOCK This security objective is met by the following SFRs:

FDP_ACC.2/ PAP Administration Management and FDP_ACF.1/ PAP Administration Management which grant an authorized user (the Issuing Bank) the privilege to block the PAP and its data.

FIA_UID.1/ Post-Issuance Bank Management and FIA_UAU.1/ Post-Issuance Bank Management that contribute to meet the objective in requiring Issuing Bank to be identified and authenticated.

FIA_AFL.1/ Issuing Bank that details which special actions shall be undertaken and refining who is an authorised subject (only Issuing Bank has the privilege to block the PAP and its data).

O.SIM_UNLOCK This security objective is covered by FIA_UAU.1/ Payment Transaction and FIA_UID.1/ Payment Transaction which require a successful identification and authentication of the customer to the (U)SIM card to perform a payment transaction.

O.AUDIT This security objective is met by the following SFRs:

FAU_GEN.1 which guarantees that auditable events are recorded

FAU_SAR.1/CUSTOMER and FAU_SAR.1/ISSUING_BANK which ensure that authorised users have the capability to read log files in a manner suitable for them to interpret the information.

O.CHANNELS This security objective is met by the following SFRs:

FMT_SMF.1/ Functionalities which ensure that the communication channels can be selected
The Select determines the contact or contactless (origin) of communication channel,

	Reference	D1270292	Release	1.01p (Printed copy not controlled: verify the version before using)
	Classification level	Public	Pages	133

O.AUDIT_ACCESS This security objective is met by the following SFRs:

FAU_SAR.1/CUSTOMER which ensure that authorised users have the capability to read log files in a manner suitable for them to interpret the information.

6.3.2 Rationale tables of Security Objectives and SFRs

Security Objectives	Security Functional Requirements	Rationale
O.TRANSACTION_UNIQUENESS	FCS_CKM.1/Session Keys , FCS_CKM.4/Session Keys , FDP_ACC.2/ P AP Application , FDP_ACF.1/ P AP Application , FDP_ETC.1 , FDP_IFC.2/ P AP Offline Authentication , FDP_IFF.1/ P AP Offline Authentication , FDP_UIT.1 , FDP_ACC.2/ P AP Activation , FDP_ACF.1/ P AP Activation , FDP_ACF.1/ P AP Administration Management , FDP_ACF.1/ P AP Payment Transaction Management , FDP_ACF.1/ P AP Offline Authentication , FDP_ACF.1/ Post-Issuance Bank Management , FDP_ACF.1/ P AP Transaction , FDP_IFC.2/ P AP Offline Transaction , FDP_IFC.2/ P AP Online Transaction , FDP_IFC.2/ Post-Issuance Bank Management , FDP_IFF.1/ P AP Offline Transaction , FDP_IFF.1/ P AP Online Transaction , FDP_IFF.1/ Post-Issuance Bank Management , FDP_ITC.1 , FDP_ACC.2/ P AP Administration Management , FDP_ACC.2/ P AP Payment Transaction Management , FDP_ACC.2/ Post-Issuance Bank Management , FDP_ACC.2/ P AP Offline Authentication , FDP_ACC.2/ P AP Transaction , FCS_COP.1/Application Cryptogram	Section 6.3.1
O.TRANSACTION_INTEGRITY	FDP_ACC.2/ P AP Application , FDP_ACF.1/ P AP Application , FDP_ETC.1 , FDP_IFC.2/ P AP Offline Authentication , FDP_ITC.2/ Post-Issuance Bank Management , FDP_ACC.2/ P AP Activation , FDP_ACF.1/ P AP Activation , FDP_ACF.1/ P AP Administration Management , FDP_ACF.1/ P AP Payment Transaction Management , FDP_ACF.1/ P AP Offline Authentication , FDP_ACF.1/ Post-Issuance Bank Management , FDP_ACF.1/ P AP Transaction , FDP_IFC.2/ P AP Offline Transaction , FDP_IFC.2/ P AP Online Transaction , FDP_IFC.2/ Post-Issuance Bank Management , FDP_ITC.1 , FDP_ACC.2/ P AP Administration Management , FDP_ACC.2/ P AP Payment Transaction Management , FDP_ACC.2/ Post-Issuance Bank Management , FDP_ACC.2/ P AP Offline Authentication , FDP_ACC.2/ P AP Transaction , FDP_IFF.1/ P AP Offline Authentication , FDP_IFF.1/ P AP Offline Transaction , FDP_IFF.1/ P AP Online Transaction , FDP_IFF.1/ Post-Issuance Bank Management , FDP_ITC.2/ P AP Transaction , FMT_MOF.1/ Parameters , FMT_MSA.1/ Issuing Bank , FMT_MSA.3 , FDP_UIT.1 , FPT_TDC.1	Section 6.3.1
O.TRANSACTION_BYPASS	FDP_ACC.2/ P AP Application , FDP_ACF.1/ P AP Application , FDP_ETC.1 , FDP_IFC.2/ P AP Offline	Section 6.3.1

	Reference D1270292	Release 1.01p <small>(Printed copy not controlled: verify the version before using)</small>
	Classification level Public	Pages 133

Security Objectives	Security Functional Requirements	Rationale
	<p> Authentication, FDP_IFF.1/ PAP Offline Authentication, FDP_ITC.2/ Post-Issuance Bank Management, FIA_UAU.1/ PAP Online Transaction, FDP_ACC.2/ PAP Activation, FDP_ACF.1/ PAP Activation, FDP_ACF.1/ PAP Administration Management, FDP_ACF.1/ PAP Payment Transaction Management, FDP_ACF.1/ PAP Offline Authentication, FDP_ACF.1/ Post-Issuance Bank Management, FDP_ACF.1/ PAP Transaction, FDP_IFC.2/ PAP Offline Transaction, FDP_IFC.2/ PAP Online Transaction, FDP_IFC.2/ Post-Issuance Bank Management, FDP_IFF.1/ PAP Offline Transaction, FDP_IFF.1/ PAP Online Transaction, FDP_IFF.1/ Post-Issuance Bank Management, FIA_UAU.1/ Post-Issuance Bank Management, FDP_ITC.1, FIA_UID.1/ PAP Online Transaction, FIA_UID.1/ Post-Issuance Bank Management, FDP_ACC.2/ PAP Administration Management, FDP_ACC.2/ PAP Payment Transaction Management, FDP_ACC.2/ Post-Issuance Bank Management, FDP_ACC.2/ PAP Transaction, FIA_AFL.1/ Customer, FIA_AFL.1/ Issuing Bank, FDP_ACC.2/ PAP Offline Authentication, FDP_ITC.2/ PAP Transaction, FIA_UAU.1/ Payment Transaction, FIA_UID.1/ Payment Transaction, FPT_TDC.1 </p>	

	Reference	D1270292	Release	1.01p (Printed copy not controlled: verify the version before using)
	Classification level	Public	Pages	133

Security Objectives	Security Functional Requirements	Rationale
O.TRANSACTION_REPLAY	FPT_RPL.1 , FIA_SOS.2 , FIA_UAU.4 , FCS_CKM.1/Session Keys , FCS_CKM.4/Session Keys , FDP_UIT.1	Section 6.3.1
O.USER_AUTH	FDP_ACC.2/ P AP Application , FDP_ACF.1/ P AP Application , FDP_RIP.1 , FIA_AFL.1/ Customer , FIA_ATD.1 , FIA_UAU.3 , FIA_UAU.4 , FCS_COP.1/Messages Data Integrity , FCS_COP.1/Messages Data Confidentiality , FDP_ACF.1/ P AP Administration Management , FDP_ACF.1/ P AP Payment Transaction Management , FDP_ACC.2/ P AP Administration Management , FDP_ACC.2/ P AP Payment Transaction Management , FIA_UAU.1/ P AP Online Transaction , FIA_UAU.6/ Customer , FIA_SOS.2 , FMT_SMR.1 , FIA_USB.1	Section 6.3.1
O.ISSUING BANK AUTH	FDP_ACC.2/ P AP Application , FDP_ACF.1/ P AP Application , FDP_ETC.1 , FIA_ATD.1 , FIA_UAU.3 , FIA_UAU.4 , FCS_COP.1/Script Processing , FCS_COP.1/Messages Data Integrity , FCS_COP.1/Messages Data Confidentiality , FDP_ACC.2/ P AP Activation , FDP_ACF.1/ P AP Activation , FDP_ACF.1/ Post-Issuance Bank Management , FIA_AFL.1/ Issuing Bank , FDP_ITC.1 , FMT_SMR.1 , FDP_ITC.2/ Post-Issuance Bank Management , FDP_ACC.2/ P AP Administration Management , FDP_ACC.2/ P AP Payment Transaction Management , FDP_ACC.2/ Post-Issuance Bank Management , FDP_ACF.1/ P AP Administration Management , FDP_ACF.1/ P AP Payment Transaction Management , FIA_SOS.2 , FIA_UAU.1/ Post-Issuance Bank Management , FIA_USB.1 , FPT_TDC.1	Section 6.3.1
O.MNO_AUTH	handled by the (U)SIM platform (O.COMM-AUTH)	
O.AUTHORISATION CONTROL	FDP_ACC.2/ P AP Application , FDP_ACF.1/ P AP Application , FIA_UAU.1/ P AP Online Transaction , FDP_ACC.2/ P AP Activation , FDP_ACF.1/ P AP Activation , FDP_ACF.1/ P AP Administration Management , FDP_ACF.1/ P AP Payment Transaction Management , FDP_ACF.1/ P AP Transaction , FDP_IFC.2/ P AP Online Transaction , FDP_IFF.1/ P AP Online Transaction , FDP_ITC.1 , FDP_ACC.2/ P AP Administration Management , FDP_ACC.2/ P AP Payment Transaction Management , FDP_ACC.2/ P AP Transaction	Section 6.3.1
O.DATA DISCLOSURE	FDP_IFF.1/ P AP Offline Authentication , FDP_IFC.2/ P AP Offline Authentication , FDP_RIP.1 , FDP_ACC.2/ P AP Application , FDP_ACF.1/ P AP Application , FDP_ITC.2/ Post-Issuance Bank Management , FDP_ETC.1 , FAU_ARP.1 , FAU_SAA.1 , FCS_COP.1/Messages Data Confidentiality ,	Section 6.3.1

	Reference D1270292	Release 1.01p <small>(Printed copy not controlled: verify the version before using)</small>
	Classification level Public	Pages 133

Security Objectives	Security Functional Requirements	Rationale
	FDP_ACC.2/ PAP Activation , FDP_ACF.1/ PAP Activation , FDP_ACF.1/ PAP Administration Management , FDP_ACF.1/ PAP Payment Transaction Management , FDP_ACF.1/ PAP Offline Authentication , FDP_ACF.1/ Post-Issuance Bank Management , FDP_ACF.1/ PAP Transaction , FDP_IFC.2/ PAP Offline Transaction , FDP_IFC.2/ PAP Online Transaction , FDP_IFC.2/ Post-Issuance Bank Management , FDP_IFF.1/ PAP Offline Transaction , FDP_IFF.1/ PAP Online Transaction , FDP_IFF.1/ Post-Issuance Bank Management , FDP_ITC.1 , FDP_ACC.2/ PAP Administration Management , FDP_ACC.2/ PAP Payment Transaction Management , FDP_ACC.2/ Post-Issuance Bank Management , FDP_ACC.2/ PAP Offline Authentication , FDP_ACC.2/ PAP Transaction , FDP_ITC.2/ PAP Transaction , FCS_COP.1/Offline Data Authentication , FCS_COP.1/Script Processing , FPR_UNO.1 , FPT_TDC.1	

	Reference	D1270292	Release	1.01p (Printed copy not controlled: verify the version before using)
	Classification level	Public	Pages	133

Security Objectives	Security Functional Requirements	Rationale
O.DATA INTEGRITY	FAU_ARP.1 , FAU_SAA.1 , FDP_ACC.2/ P AP Application , FDP_ACF.1/ P AP Application , FDP_DAU.1 , FDP_ETC.1 , FDP_IFC.2/ P AP Offline Authentication , FDP_IFF.1/ P AP Offline Authentication , FDP_ITC.2/ Post-Issuance Bank Management , FDP_SDI.2 , FDP_UIT.1 , FTP_ITC.1 , FPT_TST.1 , FMT_MTD.1/ Secrets , FCS_COP.1/Offline Data Authentication , FCS_COP.1/Application Cryptogram , FCS_COP.1/Script Processing , FCS_COP.1/Messages Data Integrity , FDP_ACC.2/ P AP Activation , FDP_ACF.1/ P AP Activation , FDP_ACF.1/ P AP Administration Management , FDP_ACF.1/ P AP Payment Transaction Management , FDP_ACF.1/ P AP Offline Authentication , FDP_ACF.1/ Post-Issuance Bank Management , FDP_ACF.1/ P AP Transaction , FDP_IFC.2/ P AP Offline Transaction , FDP_IFC.2/ P AP Online Transaction , FDP_IFC.2/ Post-Issuance Bank Management , FDP_IFF.1/ P AP Offline Transaction , FDP_IFF.1/ P AP Online Transaction , FDP_IFF.1/ Post-Issuance Bank Management , FDP_ITC.1 , FDP_ACC.2/ P AP Administration Management , FDP_ACC.2/ P AP Payment Transaction Management , FDP_ACC.2/ P AP Offline Authentication , FDP_ACC.2/ P AP Transaction , FDP_ITC.2/ P AP Transaction , FDP_ACC.2/ Post-Issuance Bank Management , FMT_MOF.1/ Parameters , FMT_MSA.1/ Issuing Bank , FMT_MSA.3 , FPT_TDC.1	Section 6.3.1
O.DATA USERS	FMT_SMR.1 , FIA_UAU.1/ P AP Online Transaction , FIA_UAU.1/ Payment Transaction , FIA_UAU.1/ Post-Issuance Bank Management , FIA_AFL.1/ Customer , FIA_AFL.1/ Issuing Bank	Section 6.3.1
O.RISK MNGT	FDP_UIT.1 , FMT_MSA.2 , FDP_ACC.2/ P AP Transaction , FDP_ACF.1/ P AP Transaction , FDP_IFC.2/ P AP Offline Transaction , FDP_IFF.1/ P AP Offline Transaction , FDP_IFC.2/ P AP Online Transaction , FDP_IFF.1/ P AP Online Transaction	Section 6.3.1
O.APP BLOCK	FIA_AFL.1/ Issuing Bank , FDP_ACC.2/ P AP Administration Management , FDP_ACF.1/ P AP Administration Management , FIA_UAU.1/ Post-Issuance Bank Management , FIA_UID.1/ Post-Issuance Bank Management	Section 6.3.1
O.SIM UNLOCK	FIA_UAU.1/ Payment Transaction , FIA_UID.1/ Payment Transaction	Section 6.3.1
O.AUDIT	FAU_GEN.1 , FAU_SAR.1/CUSTOMER , FAU_SAR.1/ISSUING BANK	Section 6.3.1
O.CHANNELS	FMT_SMF.1/ Functionalities	Section 6.3.1

	Reference D1270292	Release 1.01p <small>(Printed copy not controlled: verify the version before using)</small>
	Classification level Public	Pages 133

Security Objectives	Security Functional Requirements	Rationale
O.AUDIT_ACCESS	FAU_SAR.1/CUSTOMER,	Section 6.3.1
O.GUIS_AUTH	handled by the (U)SIM platform (O.APPLI-AUTH and O.COMM-AUTH)	

Table 13: Security Objectives and SFRs - Coverage

Security Functional Requirements	Security Objectives
FDP_ACC.2/ PAP Application	O.TRANSACTION UNIQUENESS , O.TRANSACTION INTEGRITY , O.TRANSACTION BYPASS , O.USER_AUTH , O.ISSUING BANK AUTH , O.AUTHORISATION CONTROL , O.DATA DISCLOSURE , O.DATA INTEGRITY
FDP_ACC.2/ PAP Activation	O.TRANSACTION UNIQUENESS , O.TRANSACTION INTEGRITY , O.TRANSACTION BYPASS , O.ISSUING BANK AUTH , O.AUTHORISATION CONTROL , O.DATA DISCLOSURE , O.DATA INTEGRITY
FDP_ACC.2/ PAP Administration Management	O.TRANSACTION UNIQUENESS , O.TRANSACTION INTEGRITY , O.TRANSACTION BYPASS , O.USER_AUTH , O.ISSUING BANK AUTH , O.AUTHORISATION CONTROL , O.DATA DISCLOSURE , O.DATA INTEGRITY , O.APP_BLOCK
FDP_ACC.2/ PAP Payment Transaction Management	O.TRANSACTION UNIQUENESS , O.TRANSACTION INTEGRITY , O.TRANSACTION BYPASS , O.USER_AUTH , O.ISSUING BANK AUTH , O.AUTHORISATION CONTROL , O.DATA DISCLOSURE , O.DATA INTEGRITY
FDP_ACC.2/ Post-Issuance Bank Management	O.TRANSACTION UNIQUENESS , O.TRANSACTION INTEGRITY , O.TRANSACTION BYPASS , O.ISSUING BANK AUTH , O.DATA DISCLOSURE , O.DATA INTEGRITY , O.RISK_MNGT
FDP_ACC.2/ PAP Offline Authentication	O.TRANSACTION UNIQUENESS , O.TRANSACTION INTEGRITY , O.TRANSACTION BYPASS , O.DATA DISCLOSURE , O.DATA INTEGRITY
FDP_ACC.2/ PAP Transaction	O.TRANSACTION UNIQUENESS , O.TRANSACTION INTEGRITY , O.TRANSACTION BYPASS , O.AUTHORISATION CONTROL , O.DATA DISCLOSURE , O.DATA INTEGRITY , O.RISK_MNGT
FDP_ACF.1/ PAP Application	O.TRANSACTION UNIQUENESS , O.TRANSACTION INTEGRITY , O.TRANSACTION BYPASS , O.USER_AUTH , O.ISSUING BANK AUTH , O.AUTHORISATION CONTROL , O.DATA DISCLOSURE , O.DATA INTEGRITY
FDP_ACF.1/ PAP Activation	O.TRANSACTION UNIQUENESS , O.TRANSACTION INTEGRITY , O.TRANSACTION BYPASS , O.ISSUING BANK AUTH ,

	Reference D1270292	Release 1.01p <small>(Printed copy not controlled: verify the version before using)</small>
	Classification level Public	Pages 133

Security Functional Requirements	Security Objectives
	O.AUTHORISATION CONTROL , O.DATA DISCLOSURE , O.DATA INTEGRITY



Reference

D1270292

Release

1.01p

(Printed copy not controlled: verify the version before using)

Classification level

Public

Pages

133

Security Functional Requirements	Security Objectives
FDP_ACF.1/ PAP Administration Management	O.TRANSACTION UNIQUENESS , O.TRANSACTION INTEGRITY , O.TRANSACTION BYPASS , O.USER_AUTH , O.ISSUING BANK AUTH , O.AUTHORISATION CONTROL , O.DATA DISCLOSURE , O.DATA INTEGRITY , O.APP_BLOCK
FDP_ACF.1/ PAP Payment Transaction Management	O.TRANSACTION UNIQUENESS , O.TRANSACTION INTEGRITY , O.TRANSACTION BYPASS , O.USER_AUTH , O.ISSUING BANK AUTH , O.AUTHORISATION CONTROL , O.DATA DISCLOSURE , O.DATA INTEGRITY
FDP_ACF.1/ Post-Issuance Bank Management	O.TRANSACTION UNIQUENESS , O.TRANSACTION INTEGRITY , O.TRANSACTION BYPASS , O.ISSUING BANK AUTH , O.DATA DISCLOSURE , O.DATA INTEGRITY , O.RISK MNGT
FDP_ACF.1/ PAP Offline Authentication	O.TRANSACTION UNIQUENESS , O.TRANSACTION INTEGRITY , O.TRANSACTION BYPASS , O.DATA DISCLOSURE , O.DATA INTEGRITY
FDP_ACF.1/ PAP Transaction	O.TRANSACTION UNIQUENESS , O.TRANSACTION INTEGRITY , O.TRANSACTION BYPASS , O.AUTHORISATION CONTROL , O.DATA DISCLOSURE , O.DATA INTEGRITY , O.RISK MNGT
FDP_IFC.2/ PAP Offline Authentication	O.TRANSACTION UNIQUENESS , O.TRANSACTION INTEGRITY , O.TRANSACTION BYPASS , O.DATA DISCLOSURE , O.DATA INTEGRITY
FDP_IFC.2/ PAP Offline Transaction	O.TRANSACTION UNIQUENESS , O.TRANSACTION INTEGRITY , O.TRANSACTION BYPASS , O.DATA DISCLOSURE , O.DATA INTEGRITY , O.RISK MNGT
FDP_IFC.2/ PAP Online Transaction	O.TRANSACTION UNIQUENESS , O.TRANSACTION INTEGRITY , O.TRANSACTION BYPASS , O.AUTHORISATION CONTROL , O.DATA DISCLOSURE , O.DATA INTEGRITY , O.RISK MNGT
FDP_IFC.2/ Post-Issuance Bank Management	O.TRANSACTION UNIQUENESS , O.TRANSACTION INTEGRITY , O.TRANSACTION BYPASS , O.DATA DISCLOSURE , O.DATA INTEGRITY , O.RISK MNGT
FDP_IFF.1/ PAP Offline Authentication	O.TRANSACTION UNIQUENESS , O.TRANSACTION INTEGRITY ,

	Reference D1270292	Release 1.01p <small>(Printed copy not controlled: verify the version before using)</small>
	Classification level Public	Pages 133

Security Functional Requirements	Security Objectives
	O.TRANSACTION BYPASS , O.DATA DISCLOSURE , O.DATA INTEGRITY

Security Functional Requirements	Security Objectives
FDP_IFF.1/ PAP Offline Transaction	O.TRANSACTION UNIQUENESS , O.TRANSACTION INTEGRITY , O.TRANSACTION BYPASS , O.DATA DISCLOSURE , O.DATA INTEGRITY , O.RISK MNGT
FDP_IFF.1/ PAP Online Transaction	O.TRANSACTION UNIQUENESS , O.TRANSACTION INTEGRITY , O.TRANSACTION BYPASS , O.AUTHORISATION CONTROL , O.DATA DISCLOSURE , O.DATA INTEGRITY , O.RISK MNGT
FDP_IFF.1/ Post-Issuance Bank Management	O.TRANSACTION UNIQUENESS , O.TRANSACTION INTEGRITY , O.TRANSACTION BYPASS , O.DATA DISCLOSURE , O.DATA INTEGRITY , O.RISK MNGT
FAU_ARP.1	O.DATA DISCLOSURE , O.DATA INTEGRITY
FAU_SAA.1	O.DATA DISCLOSURE , O.DATA INTEGRITY
FAU_GEN.1	O.AUDIT
FAU_SAR.1/CUSTOMER	O.AUDIT , O.AUDIT_ACCESS
FAU_SAR.1/ISSUING BANK	O.AUDIT ,
FCS_CKM.1/Session Keys	O.TRANSACTION UNIQUENESS , O.TRANSACTION REPLAY
FCS_COP.1/Offline Data Authentication	O.DATA DISCLOSURE , O.DATA INTEGRITY
FCS_COP.1/Application Cryptogram	O.TRANSACTION UNIQUENESS , O.DATA INTEGRITY
FCS_COP.1/Script Processing	O.ISSUING BANK AUTH , O.DATA DISCLOSURE , O.DATA INTEGRITY
FCS_COP.1/Messages Data Integrity	O.USER AUTH , O.ISSUING BANK AUTH , O.DATA INTEGRITY
FCS_COP.1/Messages Data Confidentiality	O.USER AUTH , O.ISSUING BANK AUTH , O.DATA DISCLOSURE
FDP_SDI.2	O.DATA INTEGRITY
FPT_TST.1	O.DATA INTEGRITY
FPT_RPL.1	O.TRANSACTION REPLAY
FDP_RIP.1	O.USER AUTH , O.DATA DISCLOSURE
FMT_SMF.1/ Functionalities	O.CHANNELS
FMT_MOF.1/ Parameters	O.TRANSACTION INTEGRITY , O.DATA INTEGRITY
FMT_MTD.1/ Secrets	O.DATA INTEGRITY
FMT_MSA.1/ Issuing Bank	O.TRANSACTION INTEGRITY , O.DATA INTEGRITY
FMT_MSA.2	O.RISK MNGT
FMT_MSA.3	O.TRANSACTION INTEGRITY , O.DATA INTEGRITY



Reference	D1270292	Release	1.01p <small>(Printed copy not controlled: verify the version before using)</small>
Classification level	Public	Pages	133

Security Functional Requirements	Security Objectives
FMT_SMR.1	O.USER_AUTH , O.ISSUING BANK AUTH , O.DATA USERS
FIA_AFL.1/ Customer	O.TRANSACTION BYPASS , O.USER_AUTH , O.APP_BLOCK , O.DATA USERS
FIA_AFL.1/ Issuing Bank	O.TRANSACTION BYPASS , O.ISSUING BANK AUTH , O.APP_BLOCK , O.DATA USERS
FIA_ATD.1	O.USER_AUTH , O.ISSUING BANK AUTH
FIA_UAU.1/ PAP Online Transaction	O.TRANSACTION BYPASS , O.USER_AUTH , O.AUTHORISATION CONTROL
FIA_UAU.1/ Post-Issuance Bank Management	O.TRANSACTION BYPASS , O.ISSUING BANK AUTH
FIA_UAU.1/ Payment Transaction	O.SIM_UNLOCK
FIA_UAU.3	O.USER_AUTH , O.ISSUING BANK AUTH
FIA_UAU.4	O.TRANSACTION REPLAY , O.USER_AUTH , O.ISSUING BANK AUTH
FIA_UAU.6/ Customer	O.USER_AUTH
FIA_UID.1/ PAP Online Transaction	O.TRANSACTION BYPASS
FIA_UID.1/ Post-Issuance Bank Management	O.TRANSACTION BYPASS
FIA_UID.1/ Payment Transaction	O.TRANSACTION BYPASS , O.SIM_UNLOCK
FIA_USB.1	O.USER_AUTH , O.ISSUING BANK AUTH
FIA_SOS.2	O.TRANSACTION REPLAY , O.USER_AUTH , O.ISSUING BANK AUTH
FDP_DAU.1	O.DATA INTEGRITY
FDP_ITC.2/ Post-Issuance Bank Management	O.TRANSACTION INTEGRITY , O.TRANSACTION BYPASS , O.ISSUING BANK AUTH , O.DATA DISCLOSURE , O.DATA INTEGRITY
FDP_ITC.2/ PAP Transaction	O.TRANSACTION INTEGRITY , O.TRANSACTION BYPASS , O.DATA DISCLOSURE , O.DATA INTEGRITY
FDP_ETC.1	O.TRANSACTION UNIQUENESS , O.TRANSACTION INTEGRITY , O.TRANSACTION BYPASS , O.ISSUING BANK AUTH , O.DATA DISCLOSURE , O.DATA INTEGRITY
FDP_ITC.1	O.TRANSACTION UNIQUENESS , O.TRANSACTION INTEGRITY , O.TRANSACTION BYPASS , O.ISSUING BANK AUTH , O.AUTHORISATION CONTROL , O.DATA DISCLOSURE , O.DATA INTEGRITY
FDP_UIT.1	O.TRANSACTION UNIQUENESS , O.TRANSACTION REPLAY ,

	Reference D1270292	Release 1.01p <small>(Printed copy not controlled: verify the version before using)</small>
	Classification level Public	Pages 133

Security Functional Requirements	Security Objectives
	O.DATA INTEGRITY , O.RISK MNGT
FPT_TDC.1	O.TRANSACTION INTEGRITY , O.TRANSACTION BYPASS , O.ISSUING BANK AUTH , O.DATA DISCLOSURE , O.DATA INTEGRITY
FTP_ITC.1	O.DATA INTEGRITY
FPR_UNO.1	O.DATA DISCLOSURE

Table 14: SFRs and Security Objectives

	Reference	D1270292	Release	1.01p <small>(Printed copy not controlled: verify the version before using)</small>
	Classification level	Public	Pages	133

6.3.3 Dependencies

6.3.3.1 SFRs Dependencies

Requirements	CC Dependencies	Satisfied Dependencies
FDP_ACC.2/ PAPER Application	(FDP_ACF.1)	FDP_ACF.1/ PAPER Application
FDP_ACC.2/ PAPER Activation	(FDP_ACF.1)	FDP_ACF.1/ PAPER Activation
FDP_ACC.2/ PAPER Administration Management	(FDP_ACF.1)	FDP_ACF.1/ PAPER Administration Management
FDP_ACC.2/ PAPER Payment Transaction Management	(FDP_ACF.1)	FDP_ACF.1/ PAPER Payment Transaction Management
FDP_ACC.2/ Post-Issuance Bank Management	(FDP_ACF.1)	FDP_ACF.1/ Post-Issuance Bank Management
FDP_ACC.2/ PAPER Offline Authentication	(FDP_ACF.1)	FDP_ACF.1/ PAPER Offline Authentication
FDP_ACC.2/ PAPER Transaction	(FDP_ACF.1)	FDP_ACF.1/ PAPER Transaction
FDP_ACF.1/ PAPER Application	(FDP_ACC.1) and (FMT_MSA.3)	FDP_ACC.2/ PAPER Application , FMT_MSA.3
FDP_ACF.1/ PAPER Activation	(FDP_ACC.1) and (FMT_MSA.3)	FDP_ACC.2/ PAPER Activation , FMT_MSA.3
FDP_ACF.1/ PAPER Administration Management	(FDP_ACC.1) and (FMT_MSA.3)	FDP_ACC.2/ PAPER Administration Management , FMT_MSA.3
FDP_ACF.1/ PAPER Payment Transaction Management	(FDP_ACC.1) and (FMT_MSA.3)	FDP_ACC.2/ PAPER Payment Transaction Management , FMT_MSA.3
FDP_ACF.1/ Post-Issuance Bank Management	(FDP_ACC.1) and (FMT_MSA.3)	FDP_ACC.2/ Post-Issuance Bank Management , FMT_MSA.3
FDP_ACF.1/ PAPER Offline Authentication	(FDP_ACC.1) and (FMT_MSA.3)	FDP_ACC.2/ PAPER Offline Authentication , FMT_MSA.3
FDP_ACF.1/ PAPER Transaction	(FDP_ACC.1) and (FMT_MSA.3)	FDP_ACC.2/ PAPER Transaction , FMT_MSA.3
FDP_IFC.2/ PAPER Offline Authentication	(FDP_IFF.1)	FDP_IFF.1/ PAPER Offline Authentication
FDP_IFC.2/ PAPER Offline Transaction	(FDP_IFF.1)	FDP_IFF.1/ PAPER Offline Transaction
FDP_IFC.2/ PAPER Online Transaction	(FDP_IFF.1)	FDP_IFF.1/ PAPER Online Transaction
FDP_IFC.2/ Post-Issuance Bank Management	(FDP_IFF.1)	FDP_IFF.1/ Post-Issuance Bank Management
FDP_IFF.1/ PAPER Offline Authentication	(FDP_IFC.1) and (FMT_MSA.3)	FDP_IFC.2/ PAPER Offline Authentication , FMT_MSA.3
FDP_IFF.1/ PAPER Offline Transaction	(FDP_IFC.1) and (FMT_MSA.3)	FDP_IFC.2/ PAPER Offline Transaction , FMT_MSA.3
FDP_IFF.1/ PAPER Online Transaction	(FDP_IFC.1) and (FMT_MSA.3)	FDP_IFC.2/ PAPER Online Transaction , FMT_MSA.3
FDP_IFF.1/ Post-Issuance Bank Management	(FDP_IFC.1) and (FMT_MSA.3)	FDP_IFC.2/ Post-Issuance Bank Management , FMT_MSA.3
FAU_ARP.1	(FAU_SAA.1)	FAU_SAA.1
FAU_SAA.1	(FAU_GEN.1)	FAU_GEN.1



Reference	D1270292	Release	1.01p <small>(Printed copy not controlled: verify the version before using)</small>
Classification level	Public	Pages	133

Requirements	CC Dependencies	Satisfied Dependencies
FAU_GEN.1	(FPT_STM.1)	
FAU_SAR.1/CUSTOMER	(FAU_GEN.1)	FAU_GEN.1
FAU_SAR.1/ISSUING BANK	(FAU_GEN.1)	FAU_GEN.1
FCS_CKM.1/Session Keys	(FCS_CKM.2 or FCS_COP.1) and (FCS_CKM.4)	FCS_COP.1/Offline Data Authentication , FCS_COP.1/Script Processing FCS_CKM.4/Session Keys
FCS_CKM.4/Session Keys	(FDP_ITC.1 or FDP_ITC.2 or (FCS_CKM.1)	FCS_CKM.1/Session Keys
FCS_COP.1/Offline Data Authentication	(FCS_CKM.1 or FDP_ITC.1 or FDP_ITC.2) and (FCS_CKM.4)	FCS_CKM.1/Session Keys
FCS_COP.1/Application Cryptogram	(FCS_CKM.1 or FDP_ITC.1 or FDP_ITC.2) and (FCS_CKM.4)	FDP_ITC.2/ PAP Transaction
FCS_COP.1/Script Processing	(FCS_CKM.1 or FDP_ITC.1 or FDP_ITC.2) and (FCS_CKM.4)	FDP_ITC.2/ Post-Issuance Bank Management
FCS_COP.1/Messages Data Integrity	(FCS_CKM.1 or FDP_ITC.1 or FDP_ITC.2) and (FCS_CKM.4)	FDP_ITC.1
FCS_COP.1/Messages Data Confidentiality	(FCS_CKM.1 or FDP_ITC.1 or FDP_ITC.2) and (FCS_CKM.4)	FDP_ITC.1
FDP_SDI.2	No Dependencies	
FPT_TST.1	No Dependencies	
FPT_RPL.1	No Dependencies	
FDP_RIP.1	No Dependencies	
FMT_SMF.1/ Functionalities	No Dependencies	
FMT_MOF.1/ Parameters	(FMT_SMF.1) and (FMT_SMR.1)	FMT_SMF.1/ Functionalities , FMT_SMR.1
FMT_MTD.1/ Secrets	(FMT_SMF.1) and (FMT_SMR.1)	FMT_SMF.1/ Functionalities , FMT_SMR.1
FMT_MSA.1/ Issuing Bank	(FDP_ACC.1 or FDP_IFC.1) and (FMT_SMF.1) and (FMT_SMR.1)	FDP_ACC.2/ Post-Issuance Bank Management , FDP_IFC.2/ Post-Issuance Bank Management , FMT_SMF.1/ Functionalities , FMT_SMR.1
FMT_MSA.2	(FDP_ACC.1 or FDP_IFC.1) and (FMT_MSA.1) and (FMT_SMR.1)	FDP_ACC.2/ Post-Issuance Bank Management , FDP_IFC.2/ Post-Issuance Bank Management , FMT_MSA.1/ Issuing Bank , FMT_SMR.1
FMT_MSA.3	(FMT_MSA.1) and (FMT_SMR.1)	FMT_MSA.1/ Issuing Bank , FMT_SMR.1



Reference	D1270292	Release	1.01p <small>(Printed copy not controlled: verify the version before using)</small>
Classification level	Public	Pages	133

Requirements	CC Dependencies	Satisfied Dependencies
FMT_SMR.1	(FIA_UID.1)	FIA_UID.1/ PAP Online Transaction , FIA_UID.1/ Post-Issuance Bank Management
FIA_AFL.1/ Customer	(FIA_UAU.1)	FIA_UAU.1/ PAP Online Transaction
FIA_AFL.1/ Issuing Bank	(FIA_UAU.1)	FIA_UAU.1/ PAP Online Transaction , FIA_UAU.1/ Post-Issuance Bank Management
FIA_ATD.1	No Dependencies	
FIA_UAU.1/ PAP Online Transaction	(FIA_UID.1)	FIA_UID.1/ PAP Online Transaction
FIA_UAU.1/ Post-Issuance Bank Management	(FIA_UID.1)	FIA_UID.1/ Post-Issuance Bank Management
FIA_UAU.1/ Payment Transaction	(FIA_UID.1)	FIA_UID.1/ Payment Transaction
FIA_UAU.3	No Dependencies	
FIA_UAU.4	No Dependencies	
FIA_UAU.6/ Customer	No Dependencies	
FIA_UID.1/ PAP Online Transaction	No Dependencies	
FIA_UID.1/ Post-Issuance Bank Management	No Dependencies	
FIA_UID.1/ Payment Transaction	No Dependencies	
FIA_USB.1	(FIA_ATD.1)	FIA_ATD.1
FIA_SOS.2	No Dependencies	
FDP_DAU.1	No Dependencies	
FDP_ITC.2/ Post-Issuance Bank Management	(FDP_ACC.1 or FDP_IFC.1) and (FPT_TDC.1) and (FTP_ITC.1 or FTP_TRP.1)	FDP_ACC.2/ Post-Issuance Bank Management , FDP_IFC.2/ Post-Issuance Bank Management , FTP_ITC.1 , FPT_TDC.1
FDP_ITC.2/ PAP Transaction	(FDP_ACC.1 or FDP_IFC.1) and (FPT_TDC.1) and (FTP_ITC.1 or FTP_TRP.1)	FDP_ACC.2/ PAP Transaction , FDP_IFC.2/ PAP Online Transaction , FTP_ITC.1 , FPT_TDC.1
FDP_ETC.1	(FDP_ACC.1 or FDP_IFC.1)	FDP_ACC.2/ PAP Application , FDP_ACC.2/ PAP Activation , FDP_ACC.2/ PAP Administration Management , FDP_ACC.2/ PAP Payment Transaction Management , FDP_ACC.2/ Post-Issuance Bank Management , FDP_ACC.2/ PAP Offline Authentication , FDP_ACC.2/ PAP Transaction , FDP_IFC.2/ PAP Offline Authentication , FDP_IFC.2/ PAP Offline Transaction , FDP_IFC.2/ PAP Online Transaction , FDP_IFC.2/ Post-Issuance Bank Management

	Reference	D1270292	Release	1.01p <small>(Printed copy not controlled: verify the version before using)</small>
	Classification level	Public	Pages	133

Requirements	CC Dependencies	Satisfied Dependencies
FDP_ITC.1	(FDP_ACC.1 or FDP_IFC.1) and (FMT_MSA.3)	FDP_ACC.2/ PAP Application , FDP_ACC.2/ PAP Activation , FDP_ACC.2/ PAP Administration Management , FDP_ACC.2/ PAP Payment Transaction Management , FDP_ACC.2/ Post-Issuance Bank Management , FDP_ACC.2/ PAP Offline Authentication , FDP_ACC.2/ PAP Transaction , FDP_IFC.2/ PAP Offline Authentication , FDP_IFC.2/ PAP Offline Transaction , FDP_IFC.2/ PAP Online Transaction , FDP_IFC.2/ Post-Issuance Bank Management , FMT_MSA.3
FDP_UIT.1	(FDP_ACC.1 or FDP_IFC.1) and (FTP_ITC.1 or FTP_TRP.1)	FDP_IFC.2/ PAP Offline Transaction , FDP_IFC.2/ PAP Online Transaction , FDP_IFC.2/ Post-Issuance Bank Management , FTP_ITC.1
FTP_ITC.1	No Dependencies	
FPR_UNO.1	No Dependencies	
FPT_TDC.1	No Dependencies	

Table 15: SFRs Dependencies

	Reference	D1270292	Release	1.01p <small>(Printed copy not controlled: verify the version before using)</small>
	Classification level	Public	Pages	133

Rationale for the exclusion of Dependencies

The dependency **FPT_STM.1** of **FAU_GEN.1** is discarded. The dependency with FPT_STM.1 is not relevant to the TOE: correctness of time is of no use for the TOE objectives.

The dependency **FCS_CKM.4** of **FCS_COP.1/Offline Data Authentication** is discarded. The [PM-1]&[PM-2] do not require any specific destruction method.

The dependency **FCS_CKM.4** of **FCS_COP.1/Application Cryptogram** is discarded. The [PM-1]&[PM-2] do not require any specific destruction method.

The dependency **FCS_CKM.4** of **FCS_COP.1/Script Processing** is discarded. The [PM-1]&[PM-2] does not require any specific destruction method.

The dependency **FCS_CKM.4** of **FCS_COP.1/Messages Data Integrity** is discarded. The [PM-1]&[PM-2] do not require any specific destruction method.

The dependency **FCS_CKM.4** of **FCS_COP.1/Messages Data Confidentiality** is discarded. The [PM-1]&[PM-2] does not require any specific destruction method.

6.3.3.2 SARs Dependencies

Requirements	CC Dependencies	Satisfied Dependencies
AVA_VAN.5	(ADV_ARC.1) and (ADV_FSP.4) and (ADV_IMP.1) and (ADV_TDS.3) and (AGD_OPE.1) and (AGD_PRE.1) and (ATE_DPT.1)	ADV_ARC.1 , ADV_FSP.4 , ADV_IMP.1 , ADV_TDS.3 , AGD_OPE.1 , AGD_PRE.1 , ATE_DPT.1
ADV_ARC.1	(ADV_FSP.1) and (ADV_TDS.1)	ADV_FSP.4 , ADV_TDS.3
ADV_FSP.4	(ADV_TDS.1)	ADV_TDS.3
ADV_IMP.1	(ADV_TDS.3) and (ALC_TAT.1)	ADV_TDS.3 , ALC_TAT.1
ADV_TDS.3	(ADV_FSP.4)	ADV_FSP.4
AGD_OPE.1	(ADV_FSP.1)	ADV_FSP.4
AGD_PRE.1	No Dependencies	
ALC_CMC.4	(ALC_CMS.1) and (ALC_DVS.1) and (ALC_LCD.1)	ALC_CMS.4 , ALC_DVS.2 , ALC_LCD.1
ALC_CMS.4	No Dependencies	
ALC_DEL.1	No Dependencies	
ALC_DVS.2	No Dependencies	
ALC_LCD.1	No Dependencies	
ALC_TAT.1	(ADV_IMP.1)	ADV_IMP.1
ASE_CCL.1	(ASE_ECD.1) and (ASE_INT.1) and (ASE_REQ.1)	ASE_ECD.1 , ASE_INT.1 , ASE_REQ.2
ASE_ECD.1	No Dependencies	
ASE_INT.1	No Dependencies	
ASE_OBJ.2	(ASE_SPD.1)	ASE_SPD.1
ASE_REQ.2	(ASE_ECD.1) and (ASE_OBJ.2)	ASE_ECD.1 , ASE_OBJ.2
ASE_SPD.1	No Dependencies	

	Reference	D1270292	Release	1.01p <small>(Printed copy not controlled: verify the version before using)</small>
	Classification level	Public	Pages	133

Requirements	CC Dependencies	Satisfied Dependencies
ASE_TSS.1	(ADV_FSP.1) and (ASE_INT.1) and (ASE_REQ.1)	ADV_FSP.4 , ASE_INT.1 , ASE_REQ.2
ATE_COV.2	(ADV_FSP.2) and (ATE_FUN.1)	ADV_FSP.4 , ATE_FUN.1
ATE_DPT.1	(ADV_ARC.1) and (ADV_TDS.2) and (ATE_FUN.1)	ADV_ARC.1 , ADV_TDS.3 , ATE_FUN.1
ATE_FUN.1	(ATE_COV.1)	ATE_COV.2
ATE_IND.2	(ADV_FSP.2) and (AGD_OPE.1) and (AGD_PRE.1) and (ATE_COV.1) and (ATE_FUN.1)	ADV_FSP.4 , AGD_OPE.1 , AGD_PRE.1 , ATE_COV.2 , ATE_FUN.1

Table 16: SARs Dependencies

6.3.4 Rationale for the Security Assurance Requirements

EAL4 allows a developer to attain a reasonably high assurance level without the need for highly specialized processes and practices. It corresponds to a white box analysis and it can be considered as a reasonable level that can be applied to an existing product line without undue expense and complexity.

6.3.5 ALC_DVS.2 Sufficiency of security measures

This component was added in order to provide a higher assurance on the security of the PAP development and manufacturing processes, especially for the secure handling of the embedded data. Those requirements appear as the most adequate ones for a manufacturing process in which several actors exchange and store highly sensitive information (confidential code, cryptographic keys, personalisation data, etc).

6.3.6 AVA_VAN.5 Advanced methodical vulnerability analysis

This component added to EAL 4 package in order to provide sufficient robustness to counter an attacker with high attack potential without the support of a protecting environment. Moreover, the PAP is a highly sensitive application. Potential attackers for such kind of applications could include experienced hackers or international organizations disposing of advanced means and resources.

	Reference	D1270292	Release	1.01p <small>(Printed copy not controlled: verify the version before using)</small>
	Classification level	Public	Pages	133

7 TOE Summary Specification

This section defines the summary specification.

7.1 Security functions

The F.REACTION function allows to:

- Manage the policy of attack reaction according to the security violations
- Manage the audit generation and review
- Manage the automatic self-tests

The F.CRYPTO_OPERATION function allows to:

- Manage the creation and deletion of cryptographic keys
- Manage the cryptographic operations
- Manage the generation of secrets

The F.ACCESS-AND-FLOW_CONTROL function allows to:

- Manage the access control and rules for following operations:
 - SELECT
 - SET STATUS
 - APPLICATION-BLOCK and APPLICATION-UNBLOCK
 - VERIFY
 - GENERATE AC
 - READ RECORD
 - PIN CHANGE-UNBLOCK and OFFLINE CHANGE-PIN
 - COUNTER RESET
 - PUT DATA
 - UPDATE RECORD
- Manage the information flow control and rules for following operations:
 - READ RECORD, GENERATE AC
 - APPLICATION-, APPLICATION-UNBLOCK, PUT DATA, UPDATE RECORD, PIN CHANGE-UNBLOCK

The F.DATA-IMPORT_EXPORT function allows to:

- Manage the import of data protected in term of integrity or confidentiality
- Manage the export of data protected in term of integrity or confidentiality

The F.CUSTOMER-AUTHENTICATION function allows to:

- Manage the customer authentication

The F.ISSUING-BANK-AUTHENTICATION function allows to:

- Manage the issuing-bank authentication

	Reference D1270292	Release 1.01p <small>(Printed copy not controlled: verify the version before using)</small>
	Classification level Public	Pages 133

The F.PROTECTION function allows to:

- Management
- Manage the integrity or confidentiality of User data and TSF data that required integrity or confidentiality
- Manage the replay detection
- Manage the residual information protection
- Manage the secure communication channel
- Manage Reference Personal Code and PAP Keys unuservability

7.2 Assurance measures

Assurance measure	Document title
MPP.ASE	Mobile Paypass v1.0 on UpTeq NFC2.0.4_OFM Security Target
MPP.ADV	ADV documents
MPP.ADV_IMP	Source code Mobile Paypass v1.0
MPP.AGD	AGD documents
MPP.ALC	ALC documents
MPP.ATE	ATE documents
MPP.AVA	Samples Mobile Paypass v1.0 on UpTeq NFC2.0.4_OFM

END OF THE DOCUMENT